

d

*This book was donated to the
Don Mills Branch Library by*

m



Wm Remies

RENNIE'S
AGRICULTURE
IN CANADA

MODERN PRINCIPLES OF
AGRICULTURE
APPLICABLE TO CANADIAN FARMING
TO YIELD GREATER
PROFIT

BY WM. RENNIE, SR.

LATE OF THE O.A.C., GUELPH

PUBLISHED BY
WM. RENNIE CO., LIMITED
TORONTO

1916

COPYRIGHT, CANADA, 1916, BY WM. RENNIE CO., LIMITED,
TORONTO.

FOREWORD

In a country famous for her vast wheat fields and whose chief industry is—and must continue to be for many years—agriculture, the need of a standard work on this important subject by a competent writer is apparent. Of the few Canadian writers with a practical knowledge of farming in Canada, who have attempted to blaze the trail for the newcomer or help the old settler with advice born of long personal experience, none occupy such a pre-eminent position as William Rennie.

Unusually successful in all departments of agriculture and with the gift of imparting information on the most prosaic subject in a fascinating manner, his personality was a potent factor in the elevation of farm work to the science of agriculture. By precept and example he enriched farm life in this country, and did much to lift it from the deadly routine which was rapidly depleting the rural population of its young life.

The author came into national prominence by winning the first Silver Medal presented by the Agricultural and Arts Association of Ontario for the cleanest and best-managed farm in the province, while his brother, the late Simpson Rennie, who occupied the Rennie homestead in Scarboro (Ont.), won the Gold Medal.

At a critical period in the history of the Ontario Agricultural College, Wm. Rennie was requested by the Hon. John Dryden, then Minister of Agricul-

ture, to take charge of the Farm, demonstrate his latest methods, as well as lecture to the students, where he served for years with credit to himself and profit to the College.

On many other occasions his wide experience and expert knowledge have been of service to the Government, when matters of vital importance to Canadian Agriculture were under consideration.

In recent years, scientific agriculture has made great strides, and much valuable information, the outcome of later experiences and investigation, is presented herewith. The book is invaluable to the Canadian farmer, as it is the only practical work on Canadian Agriculture extant: It embodies Mr. Rennie's scientific principles of soil cultivation, rotation of crops, etc., which can be followed with great profit in any country. Every department of the farm and home has been given the most careful attention, and, if farmers will adhere to the easily followed scientific instructions, they may reasonably expect a greater measure of success and a saving of labor, which will add pleasure and profit to their daily work.

The book is written in the simple, lucid style which characterized Mr. Rennie's popular lectures to students and to Farmers' Institutes.

W. R. Co.

INTRODUCTION

The man whose life is spent on the farm finds himself in the midst of surroundings conducive to the development of all that is best in humanity.

Abundance of pure air and floods of sunlight provide the essentials for maintaining the highest standard of physical vigor; freedom from the noises and excitement of the city tend to the formation of habits of quiet thought and sober reflection; special dignity and importance are given to his calling by the knowledge that something is being produced by his daily toil that is absolutely necessary to the continued existence of civilization; and, above and beyond all this, is the inspiration coming from the fact that he feels himself in a special sense a co-worker with Providence—Providence supplying the moisture and the warmth that bring to fruition the seed sown by his hand.

The young man or woman whose life has been spent on the farm has thus a decided advantage over those whose homes are in the close streets of a great city.

Life on the farm offers, too, freely and abundantly, opportunities such as are reserved to the favored few in cities, for giving beauty to the home surroundings and securing unlimited supplies of the fruits of the garden and the vine. There is room for lawn, for flowers, for graceful trees, and for the growth of delicacies and luxuries which can be plucked and used just at the time when nature has brought them to the highest state of perfection.

W. R., SR.

CONTENTS

	PAGE
FOREWORD	iii
INTRODUCTION	v
CHAPTER I.	
BEAUTIFYING THE COUNTRY HOME	9
CHAPTER II.	
THE VEGETABLE GARDEN	26
CHAPTER III.	
SMALL FRUITS	37
CHAPTER IV.	
THE ORCHARD	45
CHAPTER V.	
FARM IMPLEMENTS AND BUILDINGS	57
CHAPTER VI.	
UNDERDRAINING	78
CHAPTER VII.	
CULTIVATION OF THE SOIL	84
CHAPTER VIII.	
CULTIVATING AND SEEDING	89
CHAPTER IX.	
DESTROYING WEEDS	97
CHAPTER X.	
ROTATION OF CROPS	100
CHAPTER XI.	
GRAIN GROWING	107
CHAPTER XII.	
FIELD ROOT CROPS	115
CHAPTER XIII.	
EXHIBITION ROOTS	129

	PAGE
POTATO GROWING	131
CHAPTER XIV.	
RAPE FOR FODDER	134
CHAPTER XV.	
CORN FOR SILAGE	135
CHAPTER XVI.	
FALL CULTIVATION	148
CHAPTER XVII.	
CULTIVATION FOR SPRING CROPS	150
CHAPTER XVIII.	
ALFALFA CLOVER	163
CHAPTER XIX.	
PASTURE AND SOILING CROPS	168
CHAPTER XX.	
THREE YEAR ROTATION	170
CHAPTER XXI.	
FENCING	172
CHAPTER XXII.	
GROWING AND FEEDING OF LIVE STOCK	177
CHAPTER XXIII.	
BREEDS OF CATTLE	186
CHAPTER XXIV.	
CATTLE FOR BEEF	193
CHAPTER XXV.	
HORSES	200
CHAPTER XXVI.	
SHEEP	203
CHAPTER XXVII.	
SWINE	210
CHAPTER XXVIII.	
POULTRY	217
CHAPTER XXIX.	
WESTERN FARMING	233
CHAPTER XXX.	
SYSTEM	243
CHAPTER XXXI.	

RENNIE'S AGRICULTURE

CHAPTER I.

BEAUTIFYING THE COUNTRY HOME.

A farm home can be made attractive at very little cost. Many farm houses are too costly. If one-quarter or even one-third of the cost had been spent in laying out the grounds, and planting trees, properly arranged, it would not only have added to the comfort and appearance of the place, but would have increased the value of the farm as well. Indeed, the value of this cannot be reckoned in dollars and cents. It should be the ambition of parents to make home the brightest and most attractive spot on earth for their family.

In improving the farm, one of the most important things is to decide on the location and quantity of land to enclose for orchard, small fruits, vegetable garden, and lawn. Provision should be made at the back for a small pasture for calves, poultry, etc. *See diagram of farm.* Having decided on the location, clear away all the old fences and rubbish of every kind on the whole space intended to be enclosed. If any grading is required it should be done before commencing to cultivate. Do no more grading than is necessary, as grounds have a more natural appearance when they are somewhat undulating. The portion intended for the lawn should be heavily manured from the barnyard before plowing. The whole enclosure should be plowed shallow,

Decide the
Location for
Orchard,
Garden and
Lawn.

and thoroughly harrowed and cultivated alternately until the land is cleared of all weeds and weed seeds. The subsoil should be loosened about ten inches deep with a stiff tooth subsoiler. *See Ill. 1.*

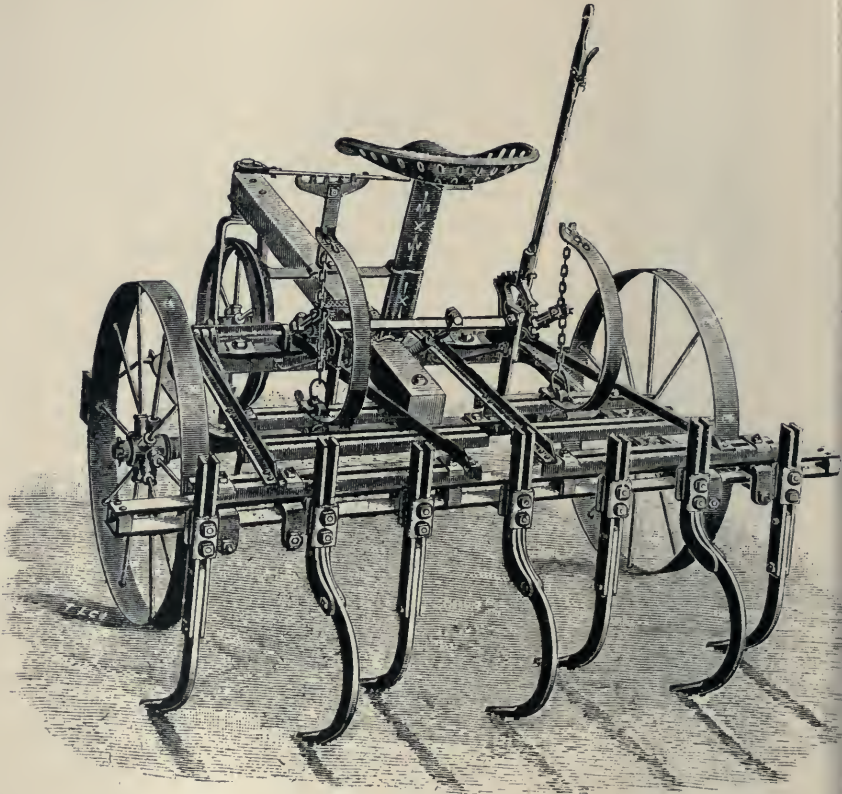

1. FOUR-HORSE SUBSOILER.

Prepare a
Plan.

Then prepare a plan, and work to it the same as a mechanic working to a plan prepared for a building.

Every farmer will require a plan especially adapted to his own place. In preparing this he should consider the location of buildings and the whole surroundings, with a view to getting the best possible effect. Good ideas of what will best suit the circumstances can be obtained by securing an inexpensive book on landscape gardening.

A wire fence should be erected around the whole of these grounds, and evergreen trees planted inside the fence. The most suitable tree for this purpose is the Norway spruce, which will answer both for a wind-break and hedge, but white cedar (*arbovitæ*) will make the most compact hedge. Trees about twenty inches high are sufficiently large for planting. Nursery trees that have been transplanted are preferable; the cost of these is about \$10.00 per hundred. For hedge work plant about eighteen inches inside of the wire fence. If you use cedar, plant the trees two feet apart, and if Norway spruce, three feet apart. If planting for a wind-break use Norway spruce, or pine, and plant from eight to ten feet apart. These will grow up with little attention, and soon become both ornamental and useful. For various reasons it is not advisable to plant a double row for a wind-break. In a few years the inside branches die for want of air, and it requires so much nourishment to support a double row that no vegetation will grow near the trees. The evergreen should not be planted too near the fruit trees, as the latter requires a fairly free passage of air to drive away moths and other insects that usually collect in close places. A single row of evergreens, planted not too closely, will make a more healthy and graceful wind-break, and will not have the objection of preventing sufficient breeze from passing through the orchard.

Enclosing the
Grounds—
Hedges and
Wind-Breaks.

Groups of
Evergreens—
Trimming
Evergreen
Hedges.

In a country with long winters, and when the deciduous trees are without their foliage, the home is more attractive and comfortable when surrounded with evergreens. One or two groups, properly located in the grounds, improve the scenery. When trimming evergreen hedges, slope the sides so that the bottom branches will get a share of the rains and dews. Cut the top even with the top wire of fence, which should not be too high. In a long hedge it is advisable to allow a tree in the hedge to grow twenty-five inches higher every fifty or sixty feet, and round the top. This improves the appearance by taking off the plainness. *See Home, North View.* At each side of the gates leave a tree about forty inches above the hedge, trimmed round or any desirable shape. For hedges, the most desirable are the cedar and Norway spruce, and where the winter is not too severe, the hemlock, with its drooping branches, makes one of the most graceful hedges. The cedar is of a slower growth, but makes the most compact hedge of any of the evergreens. Evergreen hedges should be grown close to a wire fence, so that the branches will grow through between the wires. After being trimmed outside the fence each autumn for several years, the branches will have become so interwoven with the wires that, even after the posts have decayed, the wires will remain in place, and make the hedge thoroughly stock proof, thus providing a useful and ornamental live hedge which will last for fifty years or more. There are many deciduous shrubs that make beautiful hedges during the summer months, but on account of casting their leaves in the autumn they add no attraction to the grounds when most needed. These also require the protection of a wire fence. "Spirea Van Houttei" makes a beautiful hedge when in bloom.



2. HOME—NORTH VIEW.

Avoid Straight
Drives and
Walks—Seed-
ing the Lawn.

In laying out drives and walks provide graceful curves whenever possible. Avoid a straight walk from the front door of the house to the road. Before seeding a lawn, make sure that it has been cultivated sufficiently to destroy all weeds and weed seeds. The lawn can be seeded with success any time be-



3. BRUSH HARROW.

tween early spring and the first of October. If sown after this date, in Northern Ontario, the white clover will not stand the winter. Sow the following mixture: Two pounds white clover, five pounds red top grass, three pounds Chewing's Fescue, and five pounds Kentucky blue grass (mixed) per acre, with half a bushel of barley. Sow all broadcast on the surface, after which give a stroke

with the harrow or Breed's weeder. After the barley is up several inches, cut, and leave it on the ground as a mulching. By keeping the barley cut the lawn will soon have an attractive appearance. Each spring sow a little white clover, and brush harrow the lawn thoroughly to pulverize and smooth the surface, which is usually made uneven by earth worms. *See Ill. 3.* Brush harrowing is preferable

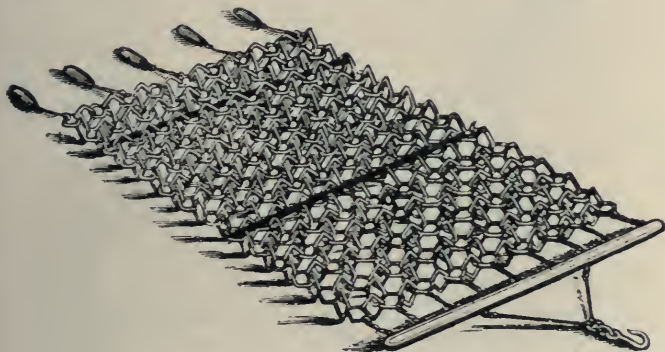

4. CHAIN HARROW.

to rolling. The chain harrow (*see Ill. 4*) does the work still more thoroughly. Clover is of very great importance in keeping up fertility on the lawn, as it collects nitrogen to feed the other grasses, and keeps the lawn green during the summer.

If the land has been thoroughly cleaned of weeds before seeding, it will require very little attention in after years. The portion used for amusements in the summer evenings will require to be cut frequently with a lawn mower. *See Ill. 5.* The balance should be cut the beginning of June. This can be done with a scythe, or a horse mowing machine. It is better not to cut during the hot summer months.

Cutting the
Lawn and
Grouping
Trees.

Groups of trees on the lawn—say, one group in front near the road, and the other at the back, give the place a park-like appearance. A variety of ever-green and deciduous trees may be planted in these groups. A crab-apple tree, and a sweet cherry tree,

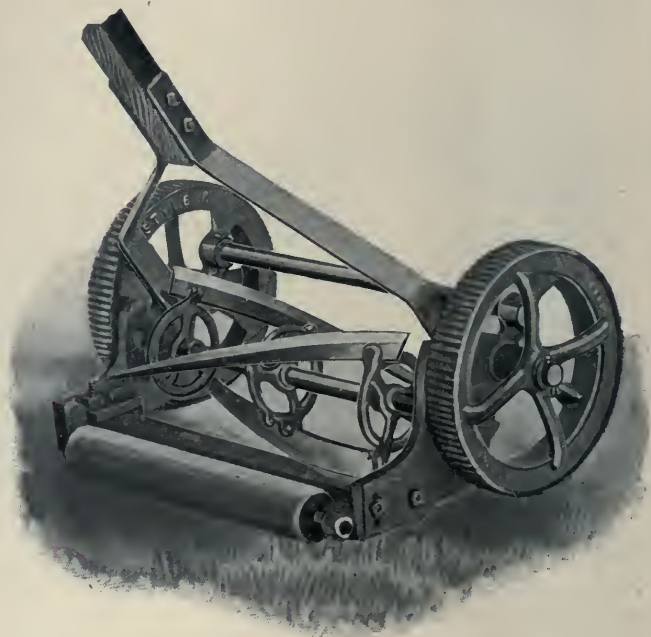

5. LAWN MOWER.

make useful and ornamental shade trees for the lawn. Groups of flowering shrubs add greatly to the attractions, but in order to get the best results from them it is advisable to dig around them. In grouping trees, or shrubs, and in making flower

beds, have no sharp angles, but round off the corners. This takes off the stiffness and gives the place a more natural appearance. In arranging groups do not plant three shrubs or trees in line. It is much more natural to have them set irregularly.

Trees, shrubs, and even flower beds, should be some distance from the house. A plain lawn, nicely kept, gives the home an attractive and quiet appearance, and by having the trees planted some distance from the home, sunlight can be given free access to all the rooms of the dwelling. *See Ill. 6.*

In making a selection of flowering shrubs two things must be observed, viz., select varieties sufficiently hardy for the locality in which they are required, and choose a collection that will bloom at various times, from early spring until autumn. The following are a few varieties that have proved sufficiently hardy in Central Ontario, where the thermometer reaches twenty-five degrees below zero: Rose-colored and white-flowered Weigelia, large-flowering Hydrangea, Tartarian Honeysuckle, Japan Quince, Spirea Van Houttei, Guelder Rose or Snowball, purple Lilac, white Lilac, Japanese Snowball, Mock Orange, and flowering Almond. They will also provide a long period of bloom.

The size and shape of flower beds will depend upon circumstances. A family who are fond of flowers will care for a larger and more varied collection than others whose tastes run in other lines, but two or three flower beds on the lawn are necessary for variety. These should be of varied shapes, and, to get satisfactory results from them, a collection of autumn bulbs, especially tulips, should be planted in October, and covered with leaves or stable manure. Snowdrops and the Crocus are the first

Selection of
Hardy Flower-
ing Shrubs.

Flower Beds.



6. MR. AND MRS. WM. RENNIE, SR., AT HOME.

to bloom in spring, and should, therefore, be included in the collection. Rake off the covering on the first

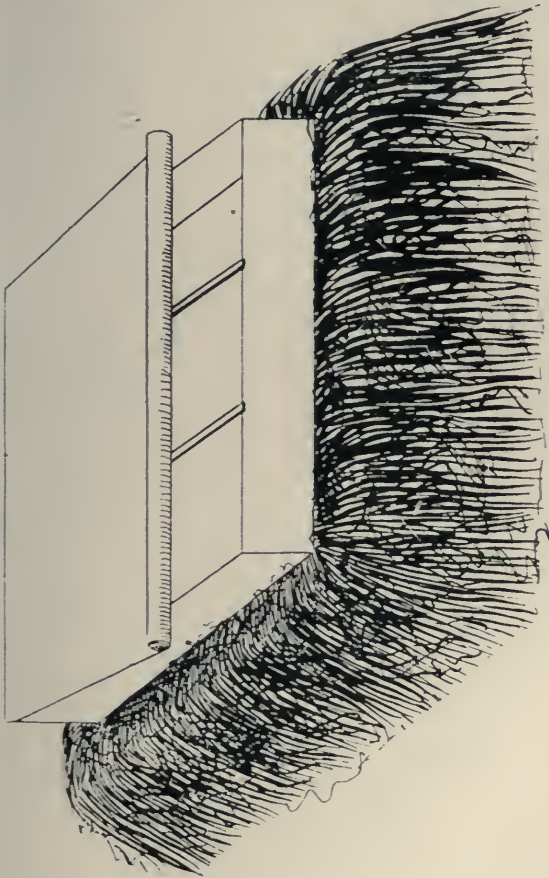

7. HOT-BED.

signs of spring, and give the little beauties a chance to show their colors. Tulips are the most popular of all Holland bulbs for outdoor planting. Between

the single and double varieties it is simply a matter of choice. Both make a magnificent display, and Darwin tulips are excellent for late flowering or for cutting for table decoration. A few Hyacinths in a flower bed, in addition to their beauty, add a pleasant odor. It is not necessary to continue the list of bulbs suitable for outdoor planting, as full illustrated lists may be had free from any seed store. Fall-planted bulbs will continue in bloom from early spring until the beginning of June, when the flower beds should be refilled with bedding-out plants, such as Cannas, Geraniums, Asters, Petunias, Phlox, etc., which will continue to bloom until late in the fall.

**How to Make a
Hot-bed.**

It is not necessary to buy either flower or vegetable plants when you can buy the seed for a mere trifle, and by making a hot-bed, grow all the plants required at little cost. *See Ill. 7.* The situation for a hot-bed should be dry underneath, and sheltered on the north and north-west by some kind of wind-break, and be fully exposed to the sun. It should be built up from two to two and a half feet high, and wider by one foot on each side than the frame which is to be placed on the heating material that forms the beds. This heating material should be fresh manure from the horse stable, with the usual amount of litter. This is thrown into a pile, and, in a few days, when fermentation has taken place, it is turned over and carefully shaken out, and formed again into a pile. This is left until the second fermentation takes place. It may then be placed in position for the hot-bed, shaped and trodden down, so that it will remain uniform. If the frame is six by nine feet, twelve inches high at the back, and eight inches high at the front, facing the south, the manure bed should be eight by eleven feet. It is not necessary to cover the frame with

glass; factory cotton is all that is necessary. Cotton is much cheaper than glass and requires less attention. Have the sheet larger than the frame so as to overlap a few inches. Have a roller about ten feet long, and the cotton tacked to it, and to the upper side of the frame. The roller will hang over the ends and prevent the wind from moving the cotton. The cotton can be rolled up to air the plants when required. After the first intense heat has passed off, cover the manure over with about six inches of soil. The soil should have been prepared the previous fall by rotting sod, and old cattle manure. When the hot-bed is completed it is advisable to let it stand two or three days until the heat moderates before planting the seeds. The time to make a hot-bed in Central Ontario is the beginning of April, so that the plants will be ready to set out by the first of June.

The selection of flower seeds best adapted for growing bedding-out plants is a matter of fancy. As a rule, preference should be given to those that bloom from the time they are set out, say the first of June, until late in autumn. The following should be included in the list: Petunia, Phlox, Salvia, Verbena, and Geraniums. The latter can be grown in a hot-bed from cuttings. For a full collection of flower seeds, see any of the seed catalogues.

It is desirable that a portion of the hot-bed be reserved for vegetable plants, for early planting, say, tomato, lettuce, cabbage, cauliflower, etc. Melons and cucumbers can be started in a hot-bed by inverting sods in the soil and planting seeds in them. By leaving a few melon plants in the hot-bed at the close of the season it will be both ornamental and useful during the summer.

In addition to a hot-bed, every farm home should have a cold frame (*see Ill. 8*) to start vegetable

Varieties of
Flowers and
Vegetables.

Cold Frames—
How to
Prepare Soil—
Covering
Frame.

plants, such as cabbage, cauliflower, tomatoes, lettuce, etc., early in the spring. Early lettuce is relished by most people and provision should be made to have some ready for use in the home as early in the season as possible. The work of preparing the soil should be done in autumn, by digging in a quantity of well-rotted farm manure, and covering a foot deep or more with coarse stable

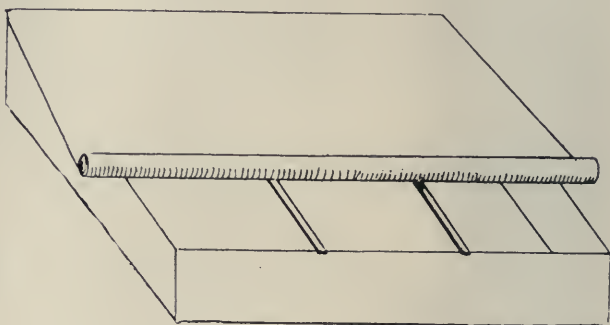

8. COLD FRAME.

manure, to prevent the soil from freezing, so that it can be planted early in the spring. Use the same style of frame as for a hot-bed. When wanted for use, remove the manure and put the frame on the soil, using the same manure to bank up the frame on the outside. Cover the frame with cotton, provided with a roller the same as for a hot-bed. It is necessary to have strips of wood three feet apart to prevent the cotton from sagging in the centre. Loosen up the soil with a spading fork before sowing seeds.

The cold frame must be sheltered from the north and west. By making due preparation, and sowing

the seeds at the end of March, the plants will be ready to set out in the open ground by the end of May. These dates are for Central and Northern Ontario. For more southern latitudes the time for sowing and planting in the open ground will vary according to location. In addition to flower beds of annuals on the lawn there should also be a bed of flowering perennials. These require very little attention. Make the bed of irregular shape, with rounded corners; dig in considerable farm manure, and mulch every winter. Plant such flowers as are hardy and showy, and that will bloom profusely. The following is a list of hardy perennials to select from. The common names only are given: Bleeding Heart, Coreopsis, Hardy Phlox, Gaillardia, Garden Pinks, Iris, Helianthus, Hollyhocks, Japanese Lilies, Delphinium, Lemon Lily, White Garden Lily, Oriental Poppy, Paeonies, Golden Glow, Sweet William. The above list will provide a collection of cut bloom sufficient to brighten the home all summer, in addition to the outdoor ornamentation.

Another attraction that may be added to the lawn is a rockery placed in some shady corner. This should be oval in shape and raised in the centre with a few wheel-barrow full of rich mould. Spade in sufficient well-rotted farm manure to prevent the soil getting hard or forming a crust. When the bed is in shape and raked, place five or six rustic stones on it, not in line or in a formal sort of way, but irregularly. The bed will then be ready for planting.

The first thing to plant is a collection of native ferns from the woods. After the ferns are planted, put in a few perennial flowers, such as the Japanese Iris, Hardy Phlox, Arabis or Rock Cress, Bleeding Heart, and Garden Pinks. This will look cosy, and require very little attention.

Time to Sow—
Flower Beds—
Hardy Perennial
Flowers.

Rockery—
Planting Ferns
and Perennial
Flowers.

Hardy
Climbers.

A few hardy climbers around the verandah of the house gives the home an artistic appearance. A few plants of Boston Ivy or Engelman's Ivy will cover the walls of a house in a few years. The ivy requires no other support than the wall to which it will cling, be it stone, brick or wood, and although it does not bloom it is very attractive. The Clematis Jackmanii has a large purple flower, and the Clematis Paniculata a small white fragrant flower. These are both hardy climbers.

Summer
Flowering
Bulbs.

A border of summer-flowering bulbs dividing the lawn from the vegetable garden is quite attractive, and as the bulbs multiply each year the principal cost is in the commencement. For the first row next the lawn, Gladioli are suggested. The flowers are bright, of various colors and charming appearance. For the second row, Cannas, dwarf sorts, will serve admirably; for the third row, Dahlias, mixed colors, including the Cactus varieties. The rows should be thirty inches apart, so that cultivating can be done with a horse. The bulbs require to be taken up in the autumn and kept in a cool cellar where they will not freeze. Should there be any danger of frost, put a little sand or mould over them in the early part of the winter.

This subject would not be complete without mentioning the queen of flowers—the Rose. In order to complete the floral department, plant a row of hardy roses four feet from the row of Dahlias, so that cultivating can be done with a horse. There are such a large variety of roses I will name only the following varieties as being suitable for outdoor blooming, and would refer to the nursery or seed catalogues for a larger collection: "Frau Karl Druschki," white; "General Jacqueminot," scarlet; "Paul Neyron," pink; "Persian Yellow." For hardy climb-

ing roses, the three well-known varieties, "Gruss an Teplitz," large flower, rich crimson color; "Dorothy Perkins," rose color; and "Crimson Rambler," still hold their own.



CRIMSON RAMBLER ROSE.

CHAPTER II.

THE VEGETABLE GARDEN.

Value of Vegetable Food in Warm Weather.

The vegetable garden should be looked on as one of the important departments of the farm. A succession of fresh vegetables from early spring is necessary for the health of all classes in this country. It is a wise provision of nature that the food we should eat can be grown in the climate in which we live. In tropical climates we find the people living almost entirely on fruits and vegetables. Were they to eat fattening foods they could not live long, as such a diet would encourage disease. In our temperate zone, where we have both heat and cold, we should govern ourselves accordingly, and so arrange that our diet during the summer season will be composed largely of fruits and vegetables. We know that our animals never thrive better than in spring on fresh grass, without any additional food. The lesson we learn from this is that a vegetable food in summer is what we require; for outdoor life in winter we need a more concentrated and heating food. In Arctic regions the food of the natives is principally the fat of whales and other sea animals, called "blubber." This is necessary to supply heat for the body.

How to Prepare the Soil for a Vegetable Garden.

It is advisable to have land for the vegetable garden thoroughly cultivated in the early fall, and an endeavor should be made to destroy all weeds and weed seeds. This will save a large amount of hand labor the following season. Before the crops are planted is the best time to clear the land of weeds. In October, when the land is in good shape, spread twenty or twenty-five loads of farm manure per

acre over the surface. Then rib the land with either a double mould-board, plow, or ribbers attached to the frame of a cultivator. Run all necessary cross furrows so that no water will lie on the surface. In the spring, when the land is required for planting, the ribs can be levelled down by harrowing and cultivating. If the soil is clay it should be loosened ten inches deep with a subsoil plow (*Ill. 9*) or a stiff-tooth subsoiler (*Ill. 1*). The above system of



9. SUBSOIL PLOW.

cultivation is recommended for market gardening. The ordinary method is to spread on the surface of the soil a heavy coat of manure, and bury it about a foot deep with an ordinary plow, turning the crude subsoil on the top, which will take a summer's cultivation to make it available for plant food. This system is in direct opposition to the laws of nature, which is to keep the vegetable matter on the surface, where the bacteria can act on it, and make it available for plant food as required. Half the quantity of manure will give better results when it is incorporated with the surface soil by cultivating and

Vegetables for
a Private
Garden.

harrowing. If market gardeners consulted their best interests they would seldom, if ever, use the ordinary plow.

Asparagus is one of the earliest vegetables. This should be planted in rows thirty inches apart, the plants nine inches apart in the row, for hand cultivation. For best results the land must be thoroughly enriched with well-rotted manure the preceding fall, as asparagus is a gross feeder. Apply a good sprinkling of salt in the spring. A good variety of asparagus is the "Columbian Mammoth." The roots can be purchased from any seed store.

Beans, dwarf or bush, should have a place in every vegetable garden. The bean, being a "Legume," is known to be one of the most nutritious and best of flesh-forming foods. A succession of sowings should be made from early spring until the middle of summer. Plant in rows two feet apart, and the seeds three inches apart in the rows and



10. THE DIBBLER.

about one and a half inches deep. The rule governing the depth of planting all seeds is from four to five times their diameter. Two varieties suitable to sow are the "Stringless Green Pod," having green pods, and the "Round Pod Kidney Wax," which has a yellow pod.

Beets for early use should be sown as soon as the ground is fit to work in spring, in rows two feet

apart, and six inches apart in the rows. For winter use it is advisable to sow in June, as this will give a crisper and better quality for use in the winter months. By using a dibbler (*see Ill. 10*), beets, and in fact, most seeds and plants, both flower and vegetable, can be grown at the desired distance apart without any variation, and this gives a garden an attractive appearance. For those who grow

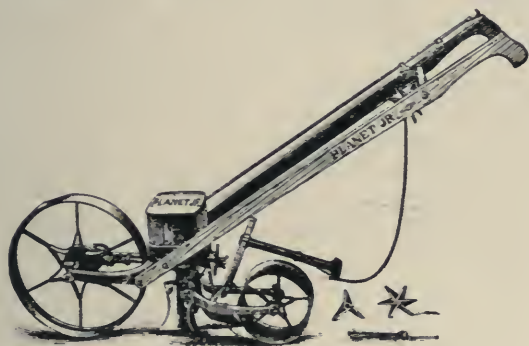

11. HILL-DROPPING SEED DRILL.

vegetables on a larger scale a hill-dropping seed-drill is preferable. *See Ill. 11.* "Crosby's Egyptian" and the "Eclipse" are two popular varieties of beets.

Cabbage.—There can be no mistake in growing a large quantity of cabbage, for should there be more than are required for home use, the balance can be fed at a profit to animals. The plants are taken from the cold frame as soon as all danger of frost is past, and planted in the vegetable garden if wanted for summer use, but those intended for use during the winter should be planted about the end of June. Plant in rows two feet apart, with the

plants eighteen inches apart in rows. For an early variety, "Early Winnigstadt" or "Copenhagen Market" answers well, and for a late variety, "Fottlér's Drumhead" or "Danish Ballhead."

Cauliflower.—This is a plant that requires abundance of moisture in order to get the best results. It is necessary to cultivate the soil every two or three days, so as to conserve all the moisture possible. As soon as the heads begin to show, tie the top leaves together with strings to prevent the heads from getting discolored. Among the reliable varieties are "Earliest Dwarf Erfurt" and "Snowball."

Carrot.—Cultivation is similar to that for beets, save that the plants should be four inches apart in the rows, instead of six. "Oxheart" and "Chantenay" are two satisfactory varieties for table use.

Celery requires a cool, moist atmosphere, and a rich black muck is especially adapted for this plant. The seeds should be sown in a cold frame or in the open ground early in the spring. Celery plants are made more stocky by cutting off the tops once or twice before transplanting. The best results are obtained by transplanting from the frame into plant boxes, then transplanting in July into rows thirty inches apart and eight inches apart in the row. Plant celery in trenches about four inches apart. When transplanting, firm the soil with the feet to ensure a start. In four or five weeks begin to earth up to give the plants an upright growth. For blanching (whitening) first use a hoe, drawing up the leaves with one hand and packing the earth around the plants with the other. Subsequent banking up can be done with the horse and plow, with a straight mould-board. To prevent the earth getting among the stalks, wrap twine once around

each plant. The last banking should be done ten or fifteen days before the celery is required for use or to be stored. In storing for winter use, dig up before the time of hard frosts and take immediately to a cool cellar and set on the floor, with boards at the sides. Bank up with sand or earth the same as for blanching in the field. "White Plume" and "Paris Golden Yellow" are two excellent varieties for table use.

Sweet Corn.—No garden would be complete without a supply of sweet corn for table use. Plant after all danger of frost is past, in hills three feet apart each way. Corn requires continuous cultivation during the growing season to conserve moisture. Desirable varieties are "Golden Bantam," "Early White Cory" and "Stowell's Evergreen."

Cucumber plants for early use can be started in the hot-bed and set in the open ground as soon as all danger of frost is past. At the same time the general crop may be planted by putting a few seeds in hills four feet apart. Pick the fruit whether it is required for use or not, as otherwise the vines will die off. Excellent varieties for table use and pickling are "Davis' Perfect," "London Long Green" and "White Spine." Pick when the desired size.

Lettuce may be sown early in the spring in rows two feet apart. Thin out for table use or for poultry and allow a certain number to heart. If sown every three weeks, fresh lettuce may be had during the summer season. "May King," "Iceberg," "Hanson" and "Nonpareil" are good varieties.

Musk Melons are greatly relished by most people, and should be cultivated in every garden. A light, warm soil is preferable, made rich with well-rotted farm manure. The cultivation necessary is the same as for cucumbers. Musk melons and

cucumbers should be kept some distance apart, otherwise they are liable to become inoculated. The "Early Hackensack" is a reliable variety of melon.

Water Melons.—The cultivation of the water melon is the same as for musk melons. "Cole's Early" and "Ice Cream" are delicious sorts.

The Citron, so well known for preserving, should be given a place in all gardens. It requires to be grown some distance from the water melons, to prevent mixing. Give the same cultivation as for melons. The "Red Seeded" is a suitable variety.

Onions.—Seed for these may be sown quite early in the spring, as a few degrees of frost will not injure the young plants. Sow in rows eighteen inches apart. After the bulbs are about half an inch in diameter, thin out. Leave the thinnings on the ground to dry off, and they can be kept over winter and planted for early use the following spring. The thinnings can be used for what are known as "Dutch or Bottom Sets." The well-known varieties are "Yellow Globe Danvers," "Red Wethersfield," and "Silverskin" for pickling.

The Parsnip is one of our most nutritious vegetables. Sow the seed early in the spring in rows two feet apart, and thin to six inches in the rows. Leave them in the ground until beginning of winter, as they are improved by the early frost. A good variety is the "Hollow Crown."

Peas, being one of the legumes, should form a portion of our daily diet. Sow early in spring, in rows two feet apart. Cultivate thoroughly. Make two or three sowings at intervals of three or four weeks. Varieties suitable are "Best Extra Early" (for first sowing), followed by "Prosperity or Gradus" and "Improved Stratagem." The last two are large, green, wrinkled sorts.

Pumpkins.—All the pumpkins required for table use may be grown along with the corn. The "Large Cheese" is a good variety.

Radish must be grown quickly in order to be crisp. Sow at intervals from early spring until autumn. To hasten vegetation, harrow or rake in land plaster before sowing. Sow in rows eighteen inches apart. Varieties: "Scarlet Turnip, white tip" and "French Breakfast."

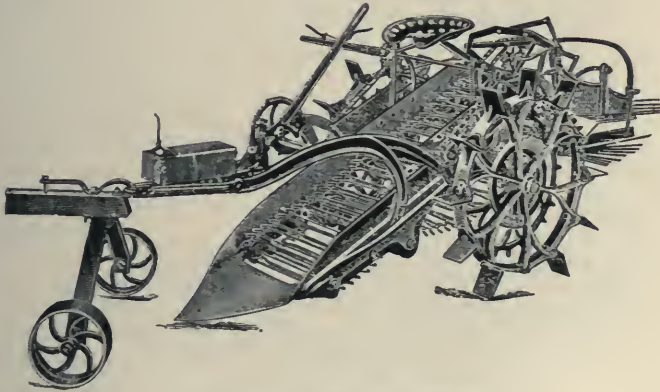

12. POTATO DIGGER AND PICKER.

Rhubarb may be grown from seed sown early in the spring, but more satisfactorily by dividing the roots and planting in rows thirty inches apart and the same distance apart in the rows. For this plant the soil cannot be too rich. Mulch in winter. "Johnston's St. Martin" is a good variety.

Squash.—The squash as a vegetable is increasing in popularity. The cultivation is similar to melons, excepting that the hills should be six to eight feet apart. For summer and early fall use sow the "Boston Marrow," and for winter the "Hubbard."

Tomatoes.—These plants are supposed to be started in a hot-bed or cold frame. For best results transplant into flat boxes, and when all danger of frost is past transplant (on a cloudy day if possible) three feet apart each way. Reliable varieties are the “Earliana” and “Livingston’s New Globe.”

Turnips.—For early turnips, sow in spring, in rows two feet apart, and thin to eight inches. For an early variety, “Early Snowball” is satisfactory, and for winter use sow “Hartley’s Bronze Top Swede” about first of July.

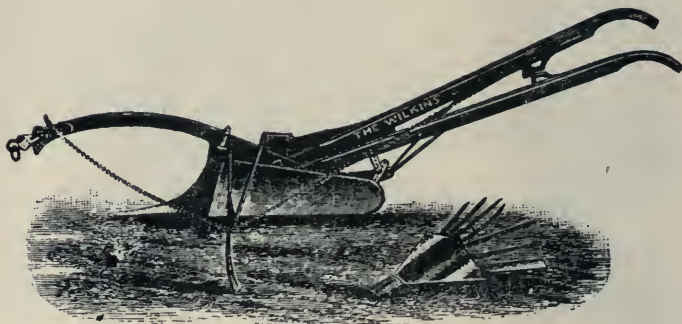

13. DRILL PLOW WITH POTATO DIGGER ATTACHMENT.

Potatoes.—In the cultivation of potatoes for early market the largest profit is from the very earliest, so that there has now come to be quite a strife among farmers and market gardeners to be first. In order to gain this, the soil, if not naturally dry and warm, must be made so by under-draining. In the autumn, give a good coat of farm manure. Then put the land up in narrow ribs for winter. In spring, harrow and cultivate the ribs down, and, on clay land, loosen the subsoil ten or twelve inches deep, and again cultivate and harrow thoroughly.

Then open the drills with a drill plow (*see Ill. 13*) four inches deep and thirty inches apart (or plant in hills thirty inches apart each way). Use medium sized potatoes; split them, dividing the seed end; plant eighteen inches apart in the row. Cover with the drill plow, and in eight days harrow down. Keep the surface pulverized with a Breed weeder or harrow tooth cultivator. *See Ill. 14*. Cultivate frequently while the potatoes are growing, to conserve moisture. The last time the earth may be thrown towards the potatoes, to cover any that may be exposed to the sun. Do not hill up potatoes.

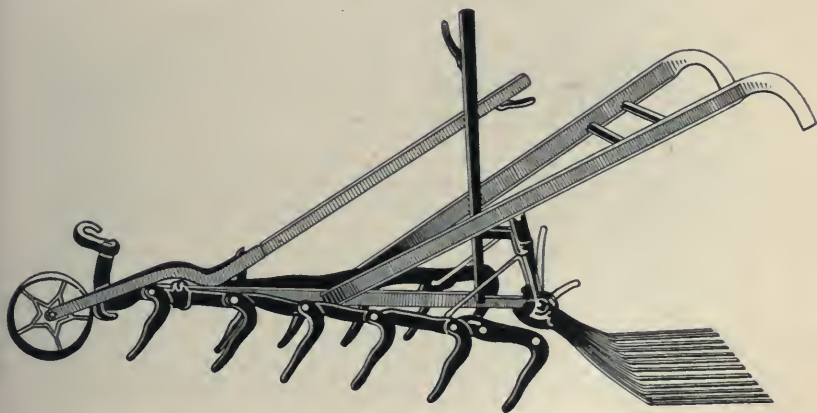

14. COMBINED HARROW, CULTIVATOR AND PULVERIZER.

Starting Hardy Sprouts.—Two weeks before planting spread the seed potatoes on the floor in a warm room, where there is plenty of sunlight, so that the hardy sprouts will start. These should not be injured. This method will insure an early crop.

Among the many early varieties that are being cultivated, these two varieties still hold their own

as the earliest and best, the "Improved Early Ohio" and the "Early Six Weeks."

Rotation in Garden.—In gardening, follow a rotation as far as practicable. After early potatoes are harvested sow peas and buckwheat to plow under. This improves the quality and texture of the soil.



IRISH COBBLER POTATOES.

CHAPTER III.

SMALL FRUITS.

The same preparation of the land necessary for vegetables is required for small fruits.

The first of the small fruits to ripen is the *Strawberries*. wholesome and appetizing strawberry. Straw-



15. MELTON STRAWBERRY.

berries should be grown in every garden. The surplus can always be disposed of at remunerative prices. The plants can be set out at any time from early spring until October. The soil should be thoroughly prepared, set in rows three feet apart and eighteen inches apart in the row. Cultivate

frequently the first season to conserve moisture and destroy all weeds.

**Renewing
Strawberries.**

Renew by setting out one-third of the whole in new plants every year. An equal portion of the old stock may be plowed under and used for some other crop. This rotation will give superior fruit. Mulch late in the fall with coarse farm manure. Uncover the crown of plants early in spring, and leave the manure for mulching. The varieties are so numerous that it is difficult to make a selection.

The Melton.

The Melton (*see Ill. 15*) is regarded as one of the best standard varieties at the present time. It has a perfect flower, ripens medium early, and produces very large fruit.

Gooseberries.

While Gooseberries do not grow to the same perfection in this country that they do in Great Britain, yet the following varieties give, as a rule, very good results: "Downing," green color (*see Ill. 16*); "Whitesmith," yellowish white; "Industry," pale red. Plant Gooseberries in rows four feet apart each way. Train the bushes in the form of a tree.

**Cultivation for
Fruits.**

In the cultivation of fruits of all kinds there should be an abundant supply of vegetable matter incorporated with the surface soil to supply plant food and act as a mulching to conserve moisture. The cultivating should be done during the spring months. In July sow red clover between the rows of bushes, and some time during the following spring spread between the rows some rotted farm manure, and plow under lightly. Then harrow and cultivate according to previous directions.

Red Currants.

No farm home is complete without a supply of Currant jelly. The planting and cultivation of Currants is similar to the method followed in Gooseberries, except that Currants may be grown in bushes instead of on a single stalk. By this means



16. DOWNING GOOSEBERRY.

the wood can be renewed by cutting out the old stalks. As a suitable red currant we would suggest the old reliable "Fay's Prolific" (*see Ill. 17*); and for a black variety the "Black Champion."

Raspberries—
Planting and
Pruning.

Raspberries come immediately after the strawberry season, and give abundance of delicious fruit



17. FAY'S PROLIFIC RED CURRANT.

at little cost. Plant and cultivate according to directions given for other small fruits. Cut out all the old wood and weak shoots each spring, leaving not more than six stalks for fruiting. No suckers should be allowed to grow outside the hills. From the long list of red varieties the following might be named: "St. Regis," for earliest (*see Ill. 18*), and

"Cuthbert" to follow. For a yellow variety use "Golden Queen."

For Black Cap berries there will be no mistake in selecting either the "Kansas" (*see Ill. 19*) or the "Gregg." "Blackberries" (brambles) are generally relished on account of their peculiar aromatic flavor. The cultivation is the same as for raspberries, except that the rows should be seven feet

Black Cap
Berries and
Brambles.



18. ST. REGIS RASPBERRY.

apart and the plants four feet apart in the row. In selecting a variety there can be no mistake in choosing either the "Snyder" or a newer variety that is claiming first place—the "Eldorado."

If one fruit is more highly esteemed than another it is the Grape. Besides its delicious fruit, the vines can be trained on a trellis or an arbor, so as to be

Grapes.

both ornamental and useful. To ensure success the cultivation and pruning must receive attention.

**How to Plant
Grapes.**

Set out in the spring, selecting good, strong vines. The soil must have been thoroughly cultivated and subsoiled. Plant in rows eight feet apart, and about sixteen feet in the row. Allow grape vines to grow the first summer without pruning. In the fall prune back, leaving three or four

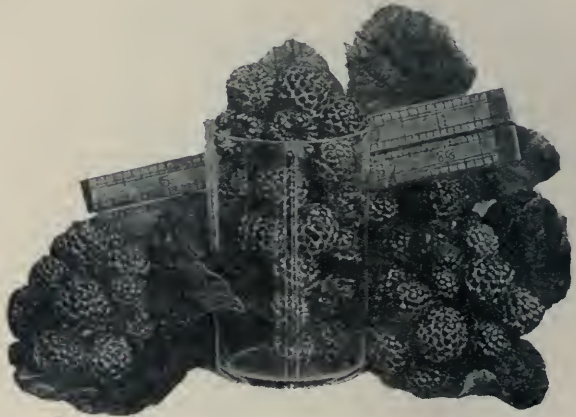

19. KANSAS BLACK CAP RASPBERRY.

buds at the bottom. The following spring allow only two of these shoots to grow, and in the fall cut them back to about four feet. The following spring these two shoots may be fastened horizontally to the lower wire of the trellis.

**How to Train
Grapes.**

The uprights should be from ten to twelve inches apart. In the fall the upright shoots should be cut back to two or three buds, and only one of these allowed to grow in the spring. In tying up grape vines use some soft material, as tow or raffia.

The cultivation of Grapes should be thorough, but should be continued only through spring and early summer. At the end of July some crop

Cultivation of
Grapes.



20. NIAGARA WHITE GRAPE.

should be sown, and allowed to remain on the surface as a mulching until the following spring. Vetches and buckwheat mixed will be found suitable for this purpose. The advantage of this method is that the

crop will use a large portion of the moisture of the soil during the months of August and September. This will allow the wood and fruit to mature earlier, and in its proper season. This mulching also prevents the frost from injuring the roots in winter, and keeps the Grapes from starting to grow too early in the spring. Plowing this under shallow, along with well-rotted farm manure, in the spring, and cultivating as in the previous year, will ensure an abundance of matured fruit.

Varieties of
Grapes.

During the past few years many new varieties of Grapes have been introduced, and after a trial have been found wanting. The following varieties can be relied on: "Campbell's Early," the "Concord" (black), the "Brighton" and "Delaware" (red), "Moore's Diamond" and "Niagara" (white), (*see Ill. 20*).

CHAPTER IV.

THE ORCHARD.

It is considered that the most suitable location for an orchard is a north-east by east exposure, for the reason that the trees thus exposed are later in blooming. Consequently there is less danger of frost destroying the fruit when it is forming. Danger from frost can, however, in a measure be obviated by mulching in the autumn.

Exposure of Orchard.

Before planting an orchard the land should be underdrained, the drains placed thirty-five feet apart, and arranged so that there will be a drain between the rows of trees. If close to the trees, the drains are liable to be choked with the rootlets. As a further preparation, clover sod should be manured and plowed down, in the fall, the same as for root crops. (See cultivation for field roots, page 115.)

Draining an Orchard.

Early spring is the proper time to plant all fruit trees. Plant an apple orchard in rows thirty-five feet apart, and thirty-five feet in the row, set alternately so as to allow more space for the trees.

Planting an Orchard.

Pears, etc., will do with twenty feet space, but when only a few of each of these are required for home use it is advisable, for convenience in cultivating, to keep them in line with the apple orchard.

Pears, Plums and Cherry Trees.

In planting any fruit, try to make the holes large enough to admit the roots without cramping or bending, and deep enough to bring the tree to its natural depth. If the subsoil is clay, loosen, after the hole is dug, with a spading fork, ten or twelve inches, so that all rain water will filter down below the roots of the tree when planted. Fine surface

soil should be used for covering the roots, and this should be carefully worked among them. If the ground is dry, it is well to pour in some water when the hole is partially filled. See that the ground is firmly packed over the roots, by exerting the full weight of the planter upon it, so that the roots will not dry out. Fill the holes full enough to be even with the surrounding surface after the fresh earth settles. *Never put manure in contact with the roots.* The young trees should be staked and tied, so that the wind will not loosen the roots. When the trees are planted they should be mulched with coarse farm manure four or five inches deep, for a space two feet more in diameter than the extent of the roots. This keeps the earth moist and of even temperature. The following spring a strip of eight or ten feet wide in line with the rows of trees should be plowed shallow, then harrowed and cultivated with wide points (to clean the land and conserve moisture) at intervals of two weeks until July. Then seed this strip with either Alfalfa or Red Clover, to remain over winter as a cover crop. In the following spring the clover should be plowed under, harrowed and cultivated until July, and again seeded with clover as in the previous year. After three years of this treatment the strip in line with the trees may be seeded with alfalfa, and allowed to remain for two years without plowing. This allows the alfalfa roots to penetrate down among the roots of the trees and perforate the subsoil.

Cropping
between the
Rows of Trees.

A hoe crop may be grown between the rows of trees the first season after planting, followed with a grain crop, seeding the second year with alfalfa. The space between the rows of trees may be seeded with alfalfa when the trees are planted. Provided the land is clean and in good condition, the alfalfa

may remain for a number of years without plowing down. The first growth can be made into hay, or cut and fed green. All animals are fond of it. It is advisable not to remove the after-growth. The



21. LOUIS PHILLIPPE CHERRY.

equivalent of whatever is removed from the soil should be returned in farm manure, and spread over the surface in winter.

The advantages from using alfalfa in an orchard are that the plants collect a large amount of free

Alfalfa as a
Fertilizer.

nitrogen from the air and the roots go down several feet, and bring up soluble mineral matter. Besides this, they perforate the subsoil among the roots of the trees, which is essential to the health of the latter. A cover crop of clover and farm manure prevents the trees from blooming too early in the spring. Although the above directions are specially applicable to the apple orchard, they are equally beneficial for other fruit trees.

Following in the order, according to diagram (page 102), cherries will come in order next to grapes. Standard trees are more suitable than dwarfs for horse cultivation. Reliable varieties of acid cherries for preserving are "Montmorency" and "Louis Phillippe" (*see Ill. 21*). The following are three satisfactory sweet cherries for table use: "Napoleon," "Elton," and "Black Tartarian."

Plums.

The plum, the most delicious of fruits, has suffered severely in past years from curculio and black knot. The former evil may be combatted by spraying with certain compounds which are dealt with more fully in the section dealing with apple culture. In the case of black knot the infected parts should be cut out and burned. Spraying the trees with Bordeaux mixture has a tendency to restrain further contagion. For an early plum, the "Burbank" might be named; for second, "Lombard" is still a favorite (*see Ill. 22*), and for autumn variety the "Reine Claude" is one of the best.

Pears.

The cultivation of the pear is extending as the value of the fruit is appreciated. The melting, juicy texture, the fine flavor and delicate aroma of the pear give it a high place among fruits. A pear orchard, properly attended to, will yield large returns, but pears require special care, particularly in picking and packing, both for home use and for



22. LOMBARD PLUM.

shipping. Two reliable summer varieties are the "Bartlett" and "Clapp's Favorite." *See Ill. 23.* For autumn, "Sheldon" is suitable, and for early winter "Anjou" and "Clairgeau."

Apples, for
Domestic Use.

The apple orchard should be divided into two departments; the first for domestic use, and the second for commercial purposes. For home use, in ordinary cases, two or three trees of the varieties named below will be sufficient for summer and early winter use. One of our best and earliest varieties is the "Yellow Transparent." Then follows the "Duchess of Oldenburg," "Snow," and "Wealthy." The balance of the orchard may be reserved for winter varieties, to be grown for export or the supply of our own markets.

Commercial
Apple Growing

Ontario is specially adapted to apple growing, and production along this line is bound to become increasingly profitable owing to the large export demand; and the growing powers of consumption in our own western and city markets. Farmers should, therefore, take advantage of the opportunity open along this line and be prepared to supply the markets available. In many cases it will be found most advantageous to sell outright to shippers in the autumn, but in a number of instances better results are being obtained by farmers joining together and handling their crops through a co-operative association. The principal point to be borne in mind is the necessity of so disposing of the crop that it will not interfere with necessary fall work on the land, which farmers cannot afford to neglect.

Plant Healthy
Trees.

In planting out an orchard first decide on the varieties, not more than two or three, which it is intended to grow for commercial purposes, and see that good healthy young trees are obtained.

For the commercial trade one of the best varieties



23. CLAPP'S FAVORITE PEAR.

is the "King." See *Ill. 24*. This is a good shipper, and commands a high price in the British market, but is a scant bearer. Other standard varieties are the "Spy," "Greening," and "Baldwin." The "Ben Davis" is one of the most prolific and also one of the best shipping apples, but the quality is decidedly inferior. As a long keeper it is without a superior. Many "Ben Davis" have been planted, and should the market become overstocked with this variety of fruit, either "King" or "Spies" should be grafted on the trees.

How to Graft.

If there are, say, four main branches to form the top, graft each alternate branch about three inches from the trunk, and horizontal, to form the top properly, and the balance the following year. Do not cut off the whole top in one year.

The "Spy," when grafted, will bear in four or five years, whereas on its own stock it will not bear for fourteen or fifteen. Other varieties will bear in three or four years after grafting. The "Tolman Sweet" is one of the best varieties to graft on. Any of the following varieties will give satisfaction for export without grafting, viz., "Ontario," "Sutton Beauty," "Baldwin," and "Greening."

Pruning Apple Trees.

Pruning fruit trees is an important matter. The time to begin is before the tree is planted, when the branches should be cut back and the top formed. Pruning should be done when the leaves are opening in the spring. When this work is attended to annually and properly there will rarely be any large limbs to cut off.

Spraying Fruit Trees.

Not the least important work in connection with fruit culture is protecting the trees and fruit against insect pests. With the proper utensils and materials this can be accomplished. First secure a good brass spraying pump mounted on a barrel supplied with



24. "KING" APPLES.



25. SPRAYING AN ORCHARD.

an agitator. Set the barrel on a cart, waggon or hand-cart, select a nozzle which is easily cleaned, and that will form a mist-like spray of the solution. As a fine spray cannot be thrown any distance, it is advisable to attach two nozzles to a bamboo pole (*see Ill. 25*) and the hose fastened to the other end of the pole.

For the treatment of scab, caterpillars, codling moth, bud moth, canker worm, leaf blight, etc., use poisoned Bordeaux mixture, by adding Paris green. This combination will destroy all masticatory and suctorial insects. The results are as good as if each were applied separately. The following is the formula: Copper sulphate, four pounds; lime, four pounds; Paris green, four ounces; water, forty gallons (one barrel). Dissolve the copper sulphate by suspending it in a bag (made of coarse material) in a wooden vessel containing about five gallons of water. It will dissolve more quickly in hot water. Slake the lime in another vessel, and strain through coarse sacking or a fine sieve; dilute the slaked lime in half a barrel of water, then pour the copper sulphate solution into the barrel, with the diluted lime. Add water to make the forty gallons; then add the Paris green, which has been previously made into a paste with water.

**Bordeaux
Mixture.**

The first spraying should be done when the buds are swelling. The second spraying when the blossoms have fallen. A third application may be necessary if any scab should appear on the fruit or disease on the leaves.

**Time to Spray
Fruit Trees.**

For blight, which frequently affects the leaves of the potato plant, and later the tubers themselves, use the same Bordeaux mixture that is recommended for fruit trees, and for the potato beetle one pound of Paris green to a barrel of water, placed on a cart

**Spraying
Potatoes.**

or other one-horse vehicle, so that while the horse is walking between two rows of potatoes the wheels will be on the opposite side of the rows, with the rows thirty inches apart. A sprayer can be made with one-inch iron gas pipe, so as to spray four or six rows at a time.



26. SPRAYING POTATOES FOR BLIGHT.

CHAPTER V.

FARM IMPLEMENTS AND BUILDINGS.

Purchase only such implements as are necessary and best suited for the different kinds of work for which they are intended. An expensive implement is not always the best. The rule should be to buy only such implements as are required, and on no account to buy an implement that is not required on the farm. The whole assortment of implements should be cared for in the best possible manner, with a view to extending their time of usefulness.

Purchasing
Implements.

The first thing is to provide an implement and tool house (*see Ill. 27*), and the second to see that every implement and tool is under cover and in its proper place when not in actual use. Exposure to rain and sun is ruinous to implements, even to those which are constructed of iron or steel. It is a saving of time and money to keep all the farm machinery, implements, etc., under cover, and in their place, and to keep every implement in good working order. The implements and tools should be painted occasionally, a work which may be done on mild days during the winter season.

Implement
House.

In one end of the implement house there should be a cheap fan forge, with an anvil and a few blacksmith's tools. Most men, if at all handy, can do ordinary repairs on the farm, and save not only expense, but also the time of going to the blacksmith shop, which is often worth more than the cost of repairing.

Blacksmith
Forge and
Tools.

In addition to a blacksmith's bench and tools, in the same end of the implement building there should

Carpenter's
Bench and
Tools.

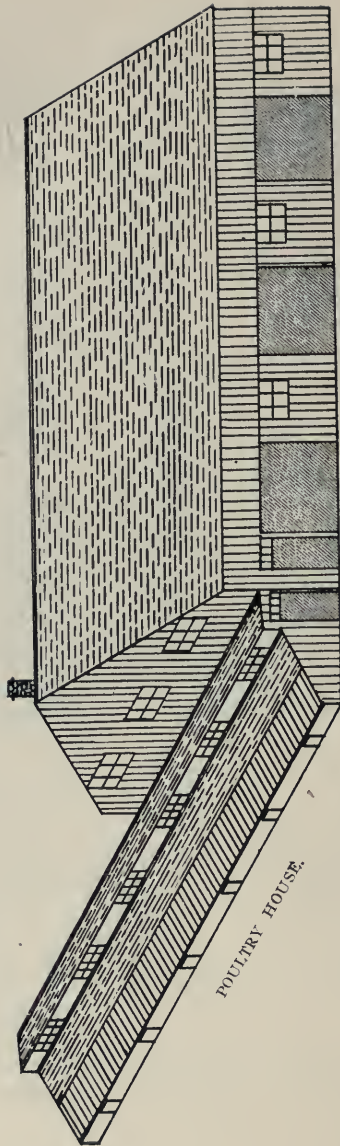

POULTRY HOUSE.

27. ELEVATION OF IMPLEMENT HOUSE.

be a carpenter's bench, provided with such tools as are necessary to do ordinary woodwork repairs. Extra sets of whiffle-trees should be kept on hand in case of breakage, and hooks for all the spades, shovels, scythes, forks, etc.

The location of the building should be convenient to both the barn and house (*see page 102*), and at the same time be isolated for safety in case of fire. The size of the building must correspond to the requirements of the farm. For a farm of, say, one hundred and fifty acres, a building sixty feet long by twenty-six feet wide (*see Ill. 28*) will not be too large for all the farm machinery, implements, waggons, sleighs, carriages, cutters, etc. The building need not be high. The floor should be low so that waggons and implements can be taken out or put in by hand. An earth floor slightly higher than the surrounding ground is all that is necessary.

Location and
Dimensions of
Building.

In a building sixty feet long, three doors are all that are required, each nine feet wide, with the spaces also nine feet. Hang the doors with pulleys on an iron bar running the whole length. The doors can all be opened without interfering with each other.

Doors with
Rollers.

The most important building on the farm is the barn. The location of the barn has much to do with the profits of the farm. Not only has the handling and storing of the crops to be considered, but the housing of the live stock, so as to get the best results at the least cost.

Farm Barn.

The first thing to be considered is the system of farming to be adopted. If dairying, will it be home dairying, or will the milk be sent to the factory, or is the intention to raise pure-bred stock? It may be that the farm and location are suitable for summer grazing and selling the stock in autumn. In

Adapted to
System of
Farming.

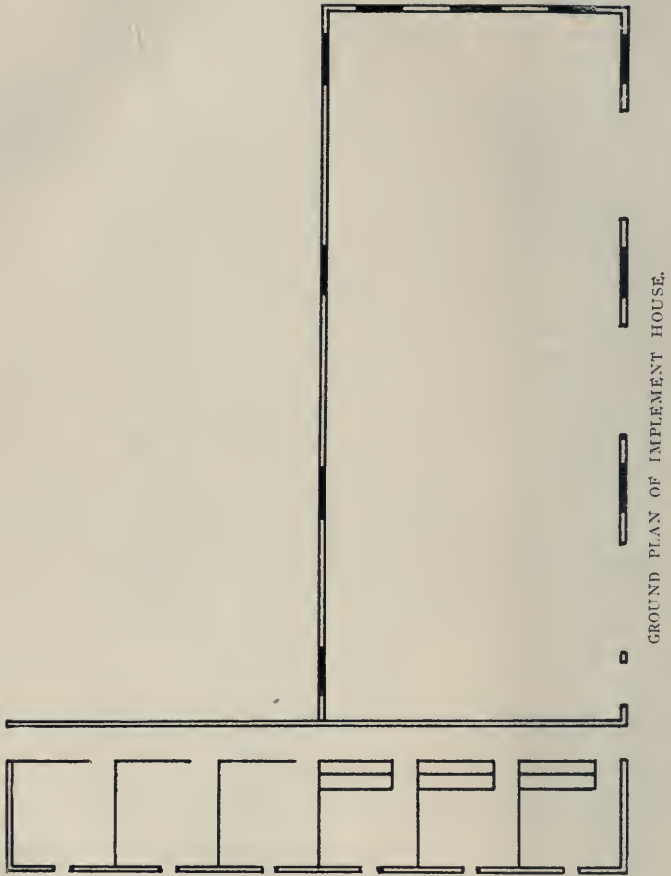

28. GROUND PLAN OF POULTRY HOUSE.

this case little or no stabling is required. The method that many are following with good results is buying stock in the autumn, fattening them during the winter, and selling in the spring. This requires considerable stable-room.

The different systems of farming require buildings specially arranged, and, in giving the design for a barn, it will have to be on general principles. In the first place, it is desirable, for convenience, to have the live stock under one roof, or in buildings close together. Horses and cattle do all right in stone or concrete basement, sheeted on the inside with lumber. Sheep and pigs do better in separate and wooden buildings. Whether a barn with an end or side drive is preferable is a debatable question. With an end drive through the centre of the building there is a large amount of space lost, since the driveway comes under the highest part of the roof. In a side drive, where the barn is over sixty feet long, it is necessary to have two drives.

Convenience of having Live Stock close together.

For a farm of from one hundred and fifty to two hundred acres, the barn should be sixty feet wide by one hundred feet long, with twenty-four feet posts. *See Elevation 29.* The mows are twenty-seven feet deep; the driveways twelve feet each, and the space between twenty-one feet, half of which is for the granary. The balance between the driveways is convenient for turning the waggons on, by driving in one way and out the other. When not required for storing grain the barn can also be used for storing chaff, which is too valuable to be used for bedding.

Size of Barn.

The whole of the ground floor of the barn should be covered with two thicknesses of inch boards, ten or twelve inches wide. First cover with inch hemlock nailed to the joists. Then cover with tarpaper, then a layer of pine boards, laid so as to break

Flooring Barn.

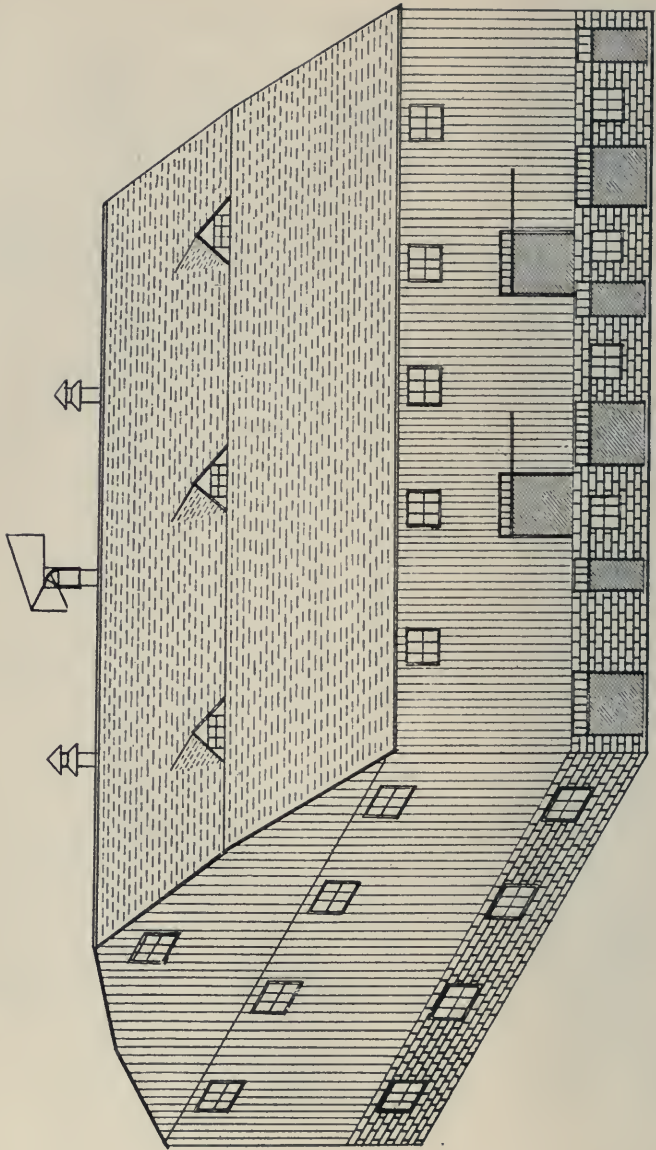

29. ELEVATION OF BARN.

the joints. The boards also require to be nailed to the joists to prevent rising caused by the steam from cattle underneath. The tar-paper, in addition to keeping vermin from eating the floor, prevents dust

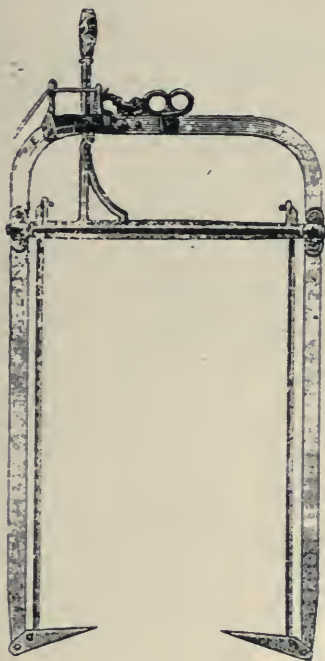

30. DOUBLE HARPOON HAY FORK.

from passing through. It is advisable to have as few beams as possible.

The barn doors should be hung with rollers on an iron bar. There should be sufficient windows for light, and these so arranged that even when the barn is filled with the crops a number of them will not be covered.

Doors and
Windows.

- Curb Roof.** The roof should not be higher than is necessary, which will save considerable in the cost. A curb roof economizes space, and with this style the barn can be better lighted. *See Elevation 29.*
- Sheeting Barn.** The sheeting for the outside of a barn and the other farm buildings may be of pine boards, one inch thick and ten inches wide, dressed on the outside. The joints should be covered with battens, one inch by two and a half, which should be nailed on perfectly perpendicular.
- Filling the Barn.** In order to save time and labor the storing of crops requires special attention. There is no difficulty in filling the bottom portion of the mows, but the question is which is the most economical and practical method of filling the top portions, particularly with sheaves. The double harpoon fork (*see Ill. 30*) is all right for hay and peas, but is useless for sheaves.
- Unloading Grain.** The slings with double power pulleys (*see Ill. 31*) handle both sheaves and hay or peas in a fairly satisfactory way. One objection is that considerable time is lost in the field in putting them in proper shape. The rack lifter has many advocates, but there is time lost in raising the load, and again in lowering the rack and replacing it on the waggon. Sheaves can be handled fairly satisfactorily by having an extra man on a scaffold.
- Entrance to Barn.** It is an advantage but not necessary for a basement barn to be on the side of a bank. For the driveways it is advisable to build a wall twelve feet from the barn, and cover it with plank. This will keep the embankment back from the basement wall and allow more light and air into the basement.
- Materials for Walls and Floors.** The material for basement walls may be either stone, brick or concrete, the latter being durable and satisfactory. The floors should be concrete.

In building and arranging a basement for barn (see *Ill. 32*) intended for live stock, it is essential to provide for light and pure air. See *Ill. 29*. According to scientific experiments, light is a prevention of

Light and Air
Essential.

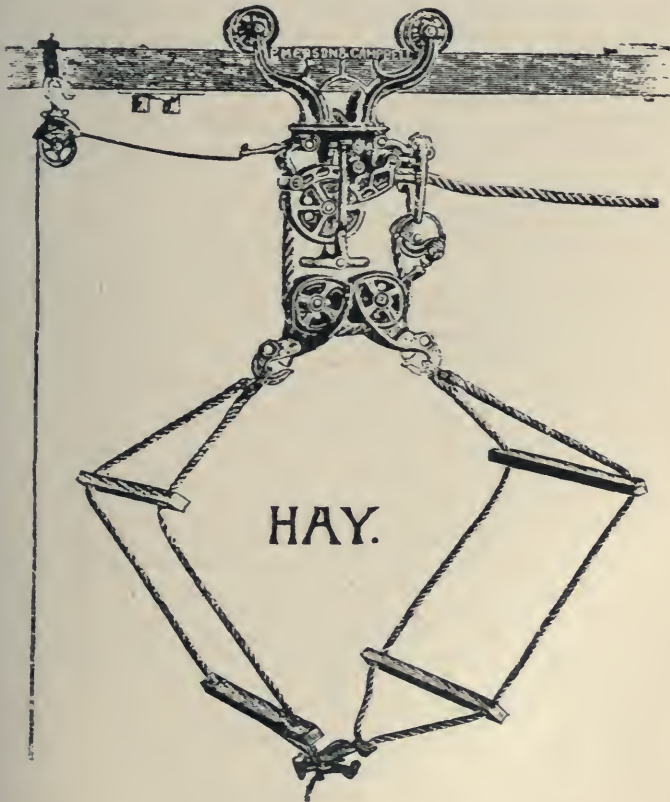

31. HAY CARRIER AND SLINGS.

many infectious diseases. It destroys bad germs, such as those of consumption and diphtheria. It is therefore important that we should arrange to get

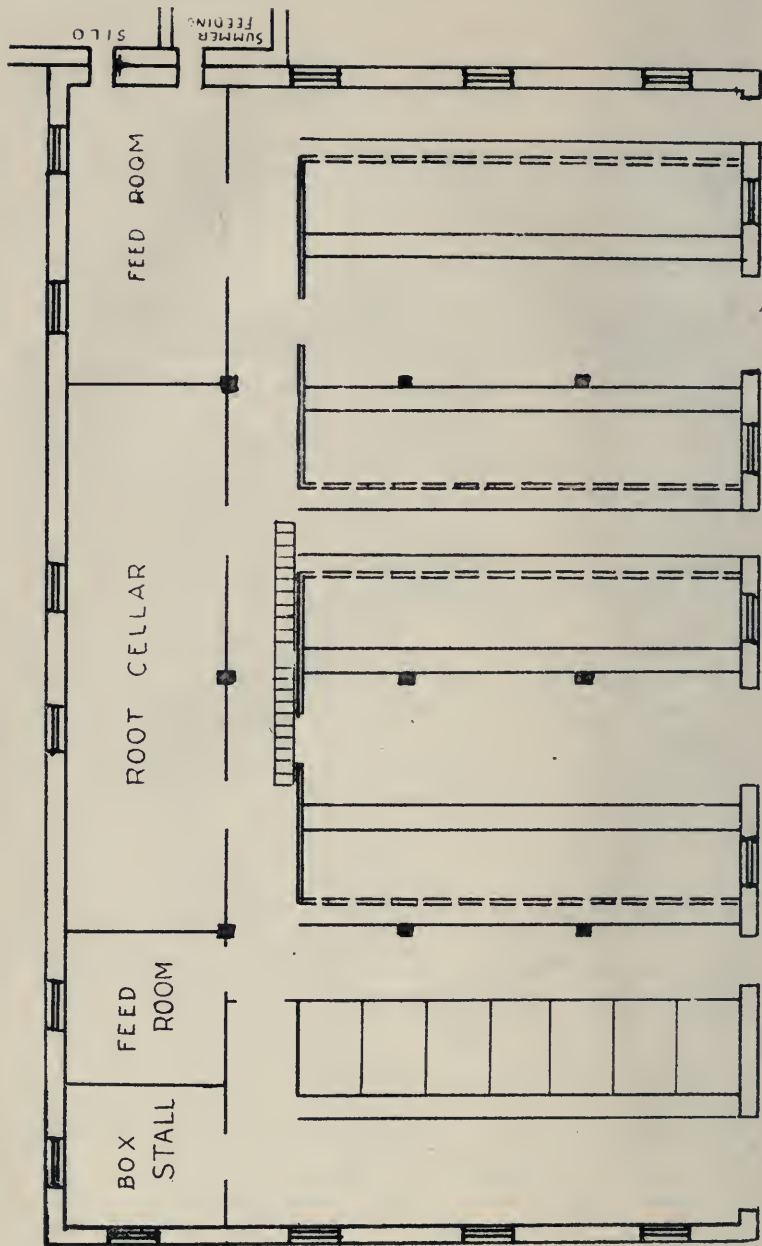

32. BASEMENT OF BARN.

Scale $\frac{1}{8}$ inch to the foot.

all the light possible, not only into our cattle stables, but into our dwelling houses. The floor of the basement should be above the barn yard, the walls ten feet high, with windows on all sides, so that the stables will be nearly as light as it is out-of-doors.

Ventilation is all important. By properly arranged ventilation the impure air is removed and replaced by pure. This constant change of air in the stables is absolutely necessary to preserve the health of the animals. Many systems have been tested during the past few years, but so far none appear to be perfect in every detail. Perhaps the nearest approach to a satisfactory automatic ventilation is the stand-up pipe, with a cowl on top to face the wind, which conducts the fresh air down and into underground pipes leading into the stable. The distributing openings may be near the ceiling. As fresh air is charged with oxygen, it is consequently much heavier than the impure air that has been breathed by the animals, and will fall to where it is required, while the impure air, being lighter than the incoming fresh air, rises upwards through flues which open into the stable at the ceiling, and run up by a post through the roof. The portion above the roof may be a round galvanized pipe, twelve inches in diameter, with a flange around the top, and a dome one foot above to cause a suction. The objection to this system is the cost. A second system is to have the cowl on the barn (*see Elevation 29*) and the pipe leading down to the ceiling of the stable. About twelve inches below the ceiling hang a platform made of inch boards about five feet square, for the down draft to strike on and be distributed. This system gives abundance of fresh air, but is not of so even a temperature as if it first passed through underground drain pipes. A third

Importance of
Ventilation.

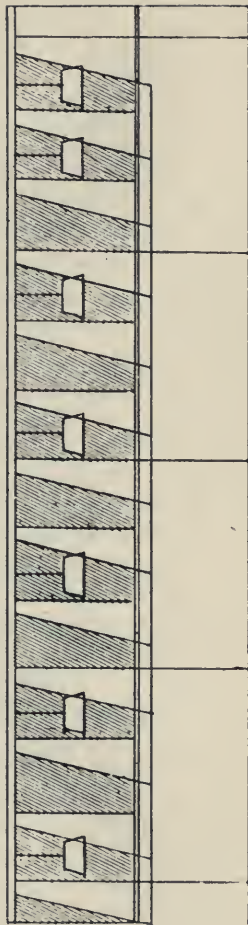

33. STATIONARY STANCHION.



34. BASEMENT FLOOR.

Scale $\frac{1}{8}$ inch to the foot.

and cheaper system is to have openings like fanlights, say twelve by thirty inches, at intervals around the walls, close to the ceiling. Fit in the openings frames hinged from the bottom, and made to open inwards from the top about one-third, or say, at an angle of about forty-five. These should be similar to the upper lights used in our railway coaches to supply fresh air. Tack muslin or cheap factory cotton on these frames. When the wind is blowing, the draft will be along the ceiling, instead of on the animals, and even when closed they will let in sufficient fresh air to keep the ceilings and the animals dry.

The following plan of basement (*see Ill. 32*) is arranged for seven horses and fifty-two cattle, and a loose-box. The stable is so arranged that box stalls can be made in the cattle compartment by using hurdles (temporary gates). There are horse and cattle feed rooms, and also a root cellar on the north side. The size of barn and basement can be increased or decreased according to the requirements. The stanchion used in some districts has the advantage of a draw rod, which opens all the stanchions in a row (*see Ill. 33*), which can again be closed as soon as the cattle are free. The swinging stanchions allow the cattle more freedom. *See Ill. 36*. Stalls in cattle stables are not necessary. By having the cattle dehorned they may be let loose for exercise in the stable without being turned out of doors in cold weather. Cast-iron basins are fastened on the partitions, arranged so that one basin will supply two animals. For details see the plan of basement (*34*).

For location of the sheep pen, see farm diagram (*page 102*).

As cattle do not thrive on the same pasture along with sheep, it is advisable not to keep both, unless

Plan of
Basement.

Sheep Pen.

Keep Cattle
and Sheep
Apart.

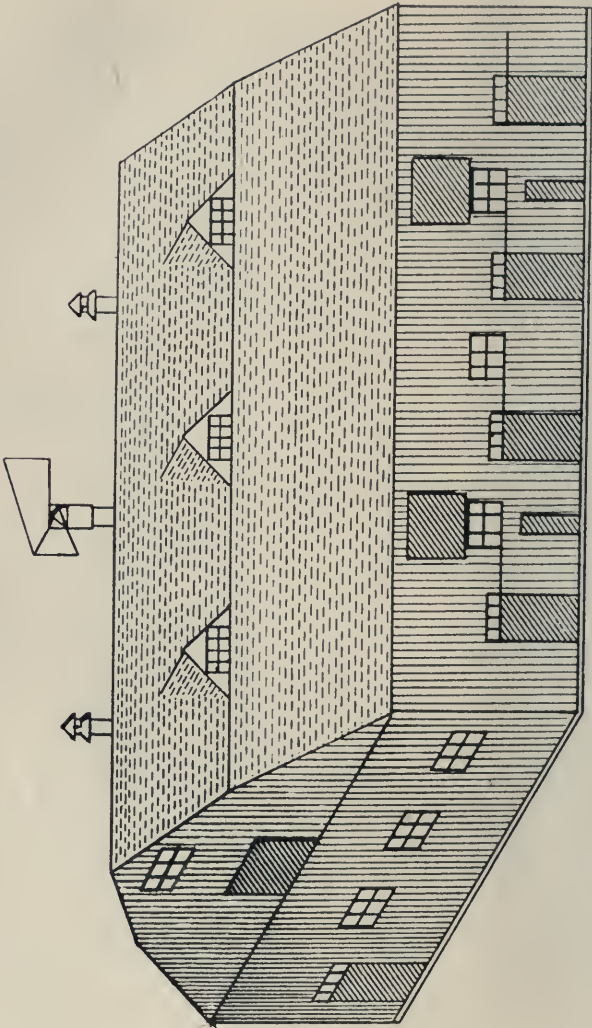

35. ELEVATION OF SHEEP HOUSE.

they can be kept in separate pastures. For winter feeding, sheep (particularly lambs) give good returns when properly managed. In the first place, they require a dry building with plenty of light and fresh air. *See Elevation 35.*

In deciding on the size of a building, allow from twenty to twenty-five square feet for each animal, according to the size. For the best average results there should not be too many together. A flock of sixty sheep will require a building thirty by sixty feet, with a passage on one side of five feet, leaving

Plan of
Building.

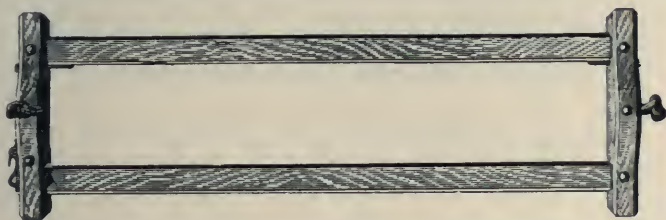

36. SWINGING STANCHION.

an inside space of fifty-nine by twenty-three feet for the sixty sheep. This should be divided into four compartments (*see Ground Plan 37*) of fourteen by twenty-three feet each in the clear, which is ample for fifteen sheep. The centre is a plain partition, while the other two answer the double purpose of partition and feed rack. *See Ill. 38.* The bottom of the rack is a plank, sixteen inches wide, raised from the floor eight inches, and on each edge a six-inch board is nailed, projecting above the plank four inches, to form a trough. Another six-inch board is made stationary, and parallel to form top of rack, leaving a space between of two and a half feet. The uprights are inch boards, eight inches wide and three feet long, nailed at the bottom and top, leaving

spaces between of seven inches for the sheep to put in their heads and feed. Whether it be grain, roots, or coarse fodder, each sheep secures an opening and cannot be moved by another. The rack has an opening at each end. The entrance next the passage is for feeding, and the other is to clean out the refuse into the yard. See *Plan 37*.

Portable
Racks.

Portable racks made on the same principle are

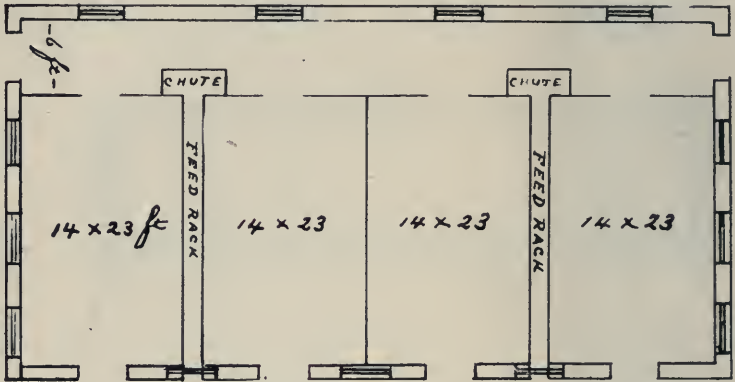

37. GROUND PLAN OF SHEEP HOUSE.

Scale $\frac{1}{4}$ inch to the foot.

convenient for feeding sheep in the yard or field. See *Ill. 38*.

Construction of
Sheep House.

An earth floor is all that is necessary for sheep. From floor to ceiling should be ten feet. The length of posts are sixteen feet from the ground to the plate, and with a curb roof leaves ample provision for clover, hay and other fodder. The stone or concrete foundation should only rise a few inches above the surface on which the posts stand. The outside sheeting may first be inch boards, put on horizontally and covered with tar-paper. Then

cover with ten-inch boards and two and a half battens, same as on the barn. It is important for the health of the sheep that they receive plenty of light. See *Plan 35*.

The ventilation for the sheep house is just as important as that for horses and cattle, and should be on the same principle. Sheep manure should not be allowed to accumulate in the pen. The gas from it is very injurious to the health of the animals.

Ventilation.



38. FEED RACK.

PIGGERY.

Not the least important of the farm buildings is the piggery. The number of pigs that can be profitably kept on a farm depends on circumstances. Pigs are more profitably fed in conjunction with a dairy. They make greater gain and give a better quality of pork when fed skim milk along with middlings and other foods.

Pigs in Conjunction with Dairy.

In deciding on the size of a building for a piggery, estimate four or five feeding pigs to consume the by-products of each cow, say forty-five feeding pigs for ten cows (see *Elevation 39*), and for space estimate twenty square feet for each pig weighing from one hundred to two hundred pounds each. A pen eight by ten feet—that is, eighty square feet—is sufficient for four pigs not exceeding two hundred pounds each.

Size of Piggery.

While the pig is by many considered a filthy animal, yet, when proper provision is made, there is

A Clean Animal.

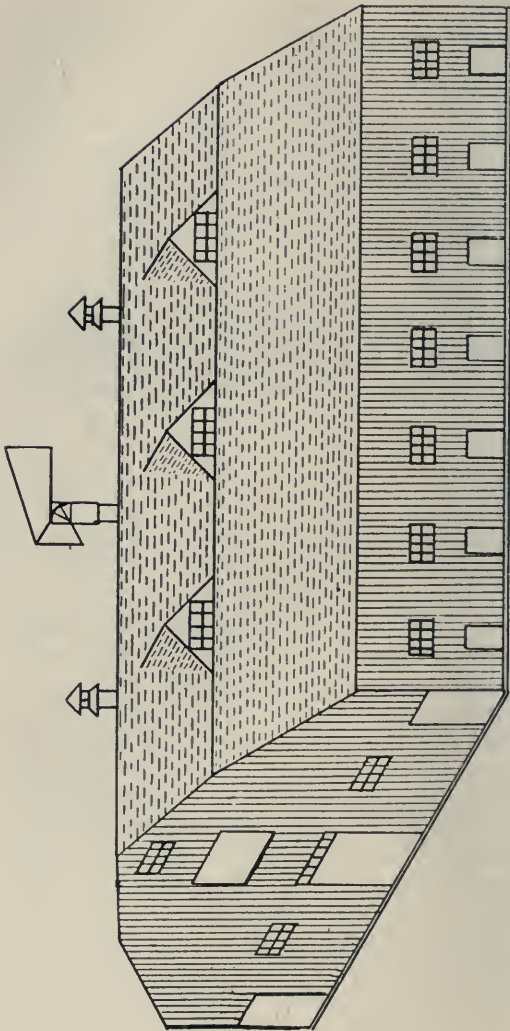

39. ELEVATION OF FIGGERY.

none more cleanly. In summer there is no difficulty in keeping the pens clean when the pigs have an outside yard, but in winter, when they must be kept inside where it is dry and warm, care and attention are necessary.

While other animals are protected against the cold with a coat of hair or wool, the pig has almost no covering. For that reason it requires special protection in order to get the best returns for the food consumed. The doors leading to the outside yards must therefore be closed in winter.

Pigs Require
Special
Protection.

It is necessary at the back of pens to have a gutter, which should be three feet wide and three inches deep. It is advisable to have the entire floor of the piggery made of cement, the beds raised two or three inches and covered with two-inch plank for protection against cold and dampness. The beds should have a three-inch scantling nailed on the edge to keep in bedding. The two seven-foot pens for brood sows (*see Ground Plan 40*) should be covered entirely with plank; also have a plank eight inches wide nailed to sides horizontally eight inches from the floor, to prevent the sow lying on her young pigs.

Gutters Inside.

It is important that a piggery should be constructed so as to be both dry and warm in winter. A wooden building on a stone or cement foundation is considered the most satisfactory. The building should be double sheeted on the outside, with tarpaper between, also sheeted on the inside up to the ceiling. The posts may be twelve feet high from the foundation, which is level with the floor, viz., eight feet to the ceiling and four feet above. For the health of the animals it is necessary to let in all the light possible. *See Elevation 39*. The size of building given in plan is thirty-two feet wide by

Wooden Build-
ing on Stone or
Cement
Foundation.

fifty-seven long. This allows three feet for the gutter in the rear, ten feet in depth for the pens, and five feet for the centre passage. The floor of the pen may be sloped to the gutter while the beds are elevated four or five inches, so that any filth that may accumulate can be swept into the gutter at the back.

Convenience in Feeding.

The trough is made V-shaped, and for this cement is the most durable. The partition over and in



40. GROUND PLAN OF PIGGERY.

Scale $\frac{1}{16}$ inch to the foot.

front of trough should be on hinges, so that, for convenience in feeding, it can be swung to the inside edge of the trough.

Style of Building.

The roof should be the same style as the barn and sheep pen, for light and uniformity.

Ventilation.

The ventilation should be on the same principle as the basement of barn. See page 66.

Convenience of Buildings.

Farm buildings constructed according to the plans and specifications given are economical, con-

sidering the advantages for convenience and health of the animals.

Painting farm buildings outside gives them a more attractive appearance, besides adding to their durability. In the erection of buildings it is advisable to have all the lumber dressed on the outside. In painting, the first thing to decide is the color. This should not be too bright. A drab with the trimmings, viz., cornices, window and door casings, a shade darker, is quiet and attractive. The following mixture makes a satisfactory drab, and is not expensive, viz.: Seventy-five pounds of mineral drab and twenty-five pounds of white lead, mixed with boiled linseed oil, and thinned with creosote or benzine. The darker shade for the trimmings can be made by adding lamp-black or mineral red. For a brown color, use pulverized brown, material mixed with linseed oil to the consistency of cream, and thin with creosote or benzine.

It is preferable to decide on a certain color and have all the buildings, etc., to harmonize.

The following is the formula for the paint or whitewash used on the Government buildings in the United States: Slake half a bushel of good stone lime in boiling water, keeping it covered while slaking. Strain and add half a peck of salt dissolved in warm water, three pounds of rice boiled to a thin paste, and half a pound of clear glue dissolved in warm water. Mix all together, and let it stand for several days. Keep in a kettle, and apply as hot as possible with a brush. It can be colored by adding ochre, lamp-black, blueing, or any other color to suit.

Painting Farm
Buildings.

Buildings, etc.,
to Harmonize.

Paint used for
U.S. Govern-
ment Buildings.

CHAPTER VI.

UNDERDRAINING.

Having dealt with the immediate surroundings of the home, the dwelling, lawn, garden, orchard and buildings, let us now turn to the fields, on the production of which the maintenance of the home depends.



JAPANESE CLEMATIS—PANICULATA. (See p. 24.)

In the old days field work was hard and there was little to relieve the drudgery. To-day, with modern implements, and by applying the principles of science to the practice of agriculture, we accomplish greater results with less labor and make farming as an occupation at once more interesting and more profitable.

Proper drainage of the land forms the very basis of successful agriculture. The soil may be ever so rich, but without sufficient drainage, either natural or artificial, its production can never reach the limit of what is possible.

It is seldom necessary to drain high, dry land. Deep subsoiling before seeding for either hoe or grain crops on such land gives very good results, especially on a clay subsoil. It improves the physical condition of clay soils by allowing the surface water to percolate into the subsoil and the air to circulate freely. A sandy or gravelly subsoil does not require loosening.

Subsoiling
Clay Lands.

The bacteria, or germs, necessary to decompose the vegetable matter can act only in dry, warm soil. Therefore, to get the best results, it is necessary to underdrain wet lands, as they are usually too cold.

Where Drains
are Needed.

Underdraining removes the surplus water in early spring, and, by causing this surplus to percolate through the soil to the drain, makes the land porous, and thus tends to retain moisture during the period of drought when it is needed.

Effect of
Underdraining.

For underdraining there is nothing more suitable than the ordinary round tile. Careful judgment should be used in the selection of the size of this, as the cost of underdraining is governed largely by the size of tile used.

Size of Drain.

For a main drain, in ordinary cases five or six-inch tile may be used for the lower end and four-inch for the upper portion; two and one-half inch to three-inch tile should be used for the laterals, or branches.

Drains should be from two and one-half to three feet deep. The distance apart between the laterals is governed by the quantity of water to be carried off

Depth of
Drains.

and the quality of the subsoil through which the drains run.

Distance
Between
Drains.

In a tenacious clay soil, forty feet apart would be considered an average distance between laterals. In a porous soil these may be from sixty to seventy-five feet apart.



41. DRAINING SPADE.

Construction
of Drain.

In commencing to drain, open up the land with an ordinary plow by passing three or four times in the same track. The subsoil can then be loosened with an ordinary subsoil plow. *See Ill. 9.*

Connecting to
Subsoil Plow.

In hitching to the subsoil plow, fasten a chain six or seven feet long to the point of beam and move the chain back on the beam as the drain is deepened.

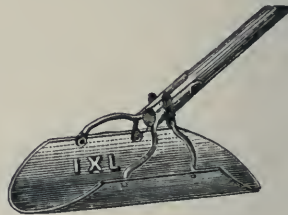

42. CRUMMER.

The evener or double tree will require to be six or seven feet long so that the horses will travel outside of the earth thrown out, one on each side.

Putting the
Earth Out of
the Drain.

The earth thus loosened will require to be thrown out after every round made by the subsoiler. This is done with narrow shovels until the drain is the required depth.

The bottom of the drain should be dug with a

narrow draining spade (*see Ill. 41*) made specially for this purpose. The loose earth is thrown out with a "crummer." *See Ill. 42.*

How to Bottom
the Drain.

➤ To secure the proper grade for the bottom of a drain, one method is to use several cross-heads made from strips of one-inch boards three or four inches

Grading.



43. DRAINING.

wide. Place the cross-heads so that the cross pieces are in line. The proper grade is ascertained by using an ordinary spirit-level. When ready to lay the drain, set a standard, or the handle of the crummer, on the bottom of the drain, and mark in line with the tops of the cross-heads. This will give a true grade for the tiles. *See Ill. 43.*

**A Satisfactory
Method.**

A second method is to fasten a spirit-level on a straight-edge about eight feet long. First find the grade that can be secured and mark the level accordingly, which will decide the grade on bottom of the drain.

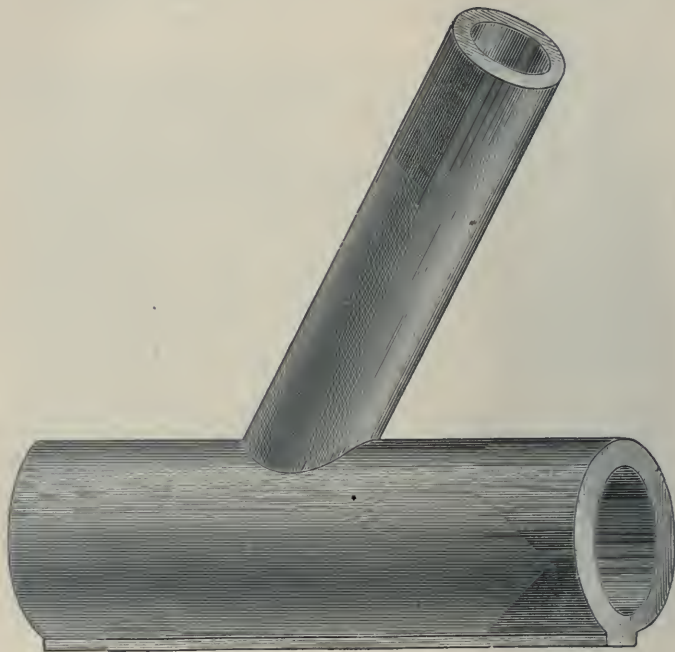

44. CONNECTING TILES IN DRAIN.

Laying Tiles.

When laying the tiles, turn them so that the joints fit close and make sure that they are firmly laid. For connections, make an opening in the main drain tile with a steel chisel, fitting the lateral tight. Tiles made with connections are more convenient. *See Ill. 44.*

In covering, put sods or the black surface soil next to the tiles. The reason for this is that the surface soil is composed of vegetable matter and will prevent the subsoil from getting in at the joints.

Covering Tiles.

If the drains are properly laid, the least perceptible fall will be sufficient to carry off the water without clogging. A correct diagram of all drains should be made and kept for future reference.

Diagram
Important.



EARLY SOY BEANS.

CHAPTER VII.

CULTIVATION OF THE SOIL.

Worn-Out Land.

Many farms in the older sections of the country have become exhausted by too deep plowing, which has buried the vegetable matter with the crude subsoil, and thus made it unavailable for plant food. This practice is contrary to the laws of nature.

How to Restore and Maintain Fertility.

In our new and fertile lands we find the vegetable matter on the surface—where it properly belongs. By shallow plowing, thorough cultivation, and a systematic rotation of crops, the fertility of the soil can be maintained indefinitely.

Causes of Worn-Out Land.

Worn-out land is really land on which the vegetable matter (humus) has been buried, or destroyed by continuous cropping with grain.

Application of Vegetable Matter.

Such land can be renewed only by applying vegetable matter on the surface and incorporating it with the surface soil so that it will decompose and form what is termed humus.

Advantages of Humus.

Humus has a distinct value apart from the plant food it contains. It absorbs and retains moisture much more readily than any other soil ingredient, so that a soil rich in humus will withstand drought without drying out and becoming hard.

Humus All Important.

Humus aids in the decomposition of mineral matter in the soil. It also fixes ammonia of animal matter and thus prevents it from being lost by leaching or evaporation. It improves the texture and mechanical condition of a heavy soil, making it lighter, more porous and less adhesive or sticky. On a sandy soil, humus serves to bind together the loose particles of sand and so prevents the soil from drifting, and arrests the excessive leaching of plant food.

Mineral fertilizers such as gypsum, lime, salt, etc., may be used on a soil that is well supplied with vegetable matter to change it into available plant food quickly; but as these are only stimulants and contain little plant food in themselves, their continued use exhausts the soil of its supplies of vegetable matter, and the result is a more rapid and complete exhaustion of fertility.

Mineral
Fertilizers
Only
Stimulate.

Without humus the soil loses its retaining power, and when these mineral fertilizers are dissolved they either evaporate or leach down beyond the reach of most plants.

Liquid
Minerals are
Lost without
Humus.

Science has proved that there is sufficient mineral matter in all ordinary soil to supply the necessary amount of phosphates required in growing crops for hundreds of years, provided a systematic rotation of crops is followed whereby clovers or some other deep-rooted plants are grown every third or fourth year to penetrate the subsoil and act on the crude mineral matter, making a certain portion available for plant food to supply the following grain and other crops forming the rotation.

Exhaustless
Quantities of
Mineral
Matter.

The practical florist can give in a lesson the value of humus. He understands that the best soil he can use for growing plants successfully is rotten sod, and none is better than the original sod from land that has not been plowed or mixed in any way with the crude subsoil. The florist cuts this sod three or four inches thick, piles it up for a time and then turns it over frequently, thereby exposing it to *heat, air and moisture*—the three essentials for rotting vegetable matter. After the sods are thoroughly rotted and mixed with decomposed farmyard manure, they are ready for use, and flower pots may be filled and the plants set in them and watered. The plants will grow and develop perfectly with

Value of
Native Sod.

very little attention, as this kind of soil will hold water like a sponge and will not get hard or crack open. This illustration will furnish valuable information for the women folk in growing house plants.

The method followed by the old-time florist was to take soil, regardless of vegetable matter, have it



45. A BEAN CROP IN WESTERN ONTARIO.

analyzed to find exactly what proportions of nitrogen, potash, phosphoric acid, etc., were required for plant growth. After the soil was thoroughly prepared with the necessary fertilizers incorporated in it, the pots were filled with plants and watered, same as the soil made from rotted sod. The results are entirely different. The soil prepared with fertilizers without humus will require watering at least every other day, otherwise it will get hard and compact and the plants will die for lack of moisture. If it is kept thoroughly watered, the fertilizers will

soon become dissolved and leach down beyond the reach of the plants and so become useless.

From the above illustration we understand that the fertility of the soil depends largely upon the amount and quality of vegetable matter it contains.

When we speak of worn-out land we do not mean the quality of the subsoil, as that undergoes little or no change. The whole difficulty is in the lack of

Worn-Out
Land Means
Lack of
Humus.

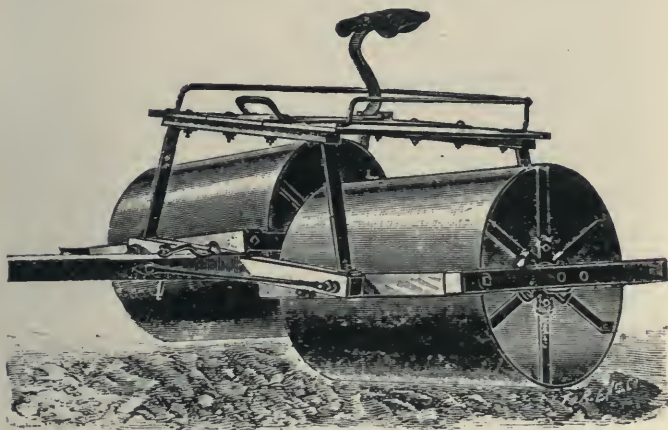

46. LAND ROLLER.

vegetable matter on the surface. When this is destroyed by deep plowing and lack of a proper system of rotation, the soil will become hard and crack open unless there is rain every few days throughout the summer months. Soil which lacks decomposed vegetable matter is of a light color, while a rich soil, filled with humus, is dark.

In adopting a system of rotation of crops, a bare summer fallow need not be included, because plowing, harrowing and cultivating the land several times

Bare Summer
Fallow.

during the summer season adds nothing to its fertility, and is particularly destructive to the humus.

Cultivation
Makes
Vegetable
Matter
Soluble.

Summer fallowing temporarily puts the soil in better condition by improving the tilth, thus making the plant food already in the soil soluble, so that a crop of wheat or any other grain will grow luxuriantly, but a large portion of plant food is lost through leaching and evaporation. In addition to this there is the loss of one season's crop and also much of the cost of labor spent in cultivating the land while under summer fallow.

Renewing
Worn-Out
Lands.

Vegetable matter and nitrogen are the two most essential elements in improving the fertility of the soil, and both are easily supplied by adopting shallow plowing and growing an abundance of alfalfa and red clover, or other leguminous plants that are adapted to collect free nitrogen from the air and deposit it in the soil.

Minerals,
Converted.

The roots of alfalfa and red clover act upon the crude mineral matter and convert it to available plant food.

CHAPTER VIII.

CULTIVATING AND SEEDING.

To prepare worn-out land for a systematic rotation of crops, plow in the spring, not more than four inches deep, then roll with a heavy roller. *Ill.*

Preparing for
Rotation.



47. SPRING TOOTH CULTIVATOR.

46. This will press the shallow furrow on the subsoil and connect the moisture from the subsoil into the furrow by what is known as capillary attraction. Moisture rises from the subsoil to the surface by the heat of the sun drying the surface soil and the fibre of decomposed plant roots. This is called "capillary attraction."

Preventing
Evaporation.

To prevent the moisture from escaping through evaporation, the connection must be cut off below the surface. This is accomplished by keeping the surface cultivated, thus forming a mulch which keeps the soil moist. Decomposition is also hastened in the same way by the three essentials for

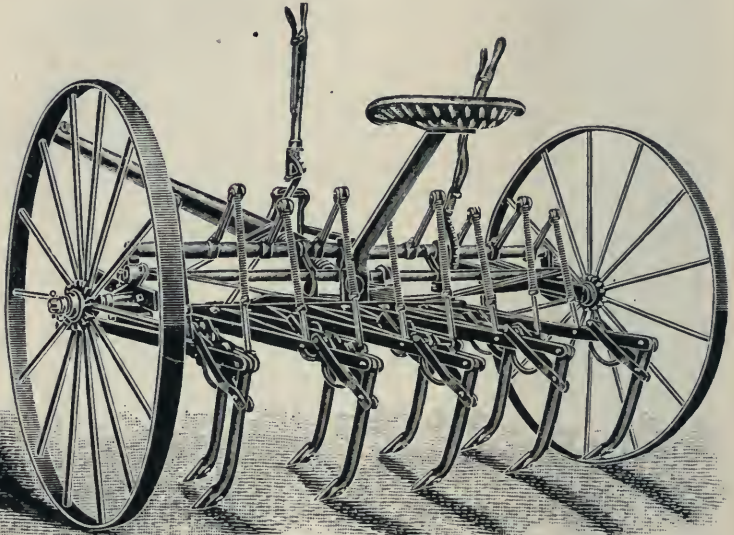

48. STIFF TOOTH CULTIVATOR.

rotting vegetable matter—"heat," by plowing in warm weather; "air," by shallow plowing; "moisture," by rolling and harrowing.

Cleaning Land
of Weeds.

If there are any thistles, couch-grass or weeds of any kind, they will soon start to grow under this treatment. When nicely started, cut them off two or three inches below the surface with wide points on the cultivator, either the "spring" or "stiff-tooth"

(*Ills. 47 and 48*), then harrow, shaking out the roots to dry in the sun. In about ten days repeat the cultivating and harrowing.

The land should now be in a good condition for growing a green crop to plow under later, to supply vegetable matter. Sow, with a grain drill (*Ill. 56*), the following mixture: 1 bushel of peas or vetches, half a bushel of buckwheat, and four pounds of Essex rape, to the acre.

Increasing
Fertility.



49. PLOW WITH REVOLVING COULTER.

When the grain is in bloom plow the whole under about four inches deep, using a chain attached to the beam of plow and the end of evener or double tree, forming a loop to draw the green crop under the furrow. A revolving coulters (*Ill. 49*) is preferable to the common straight coulters. Roll and harrow immediately the land that has been plowed. In about ten days the green crop will be sufficiently rotted to allow the use of the cultivator followed by the harrow.

Plowing under
Green Crop.

If any or all of the land that has been treated according to the foregoing directions is wanted for fall wheat, apply farmyard manure at the rate of ten or twelve loads per acre. The manure should

Preparing for
Fall Wheat.

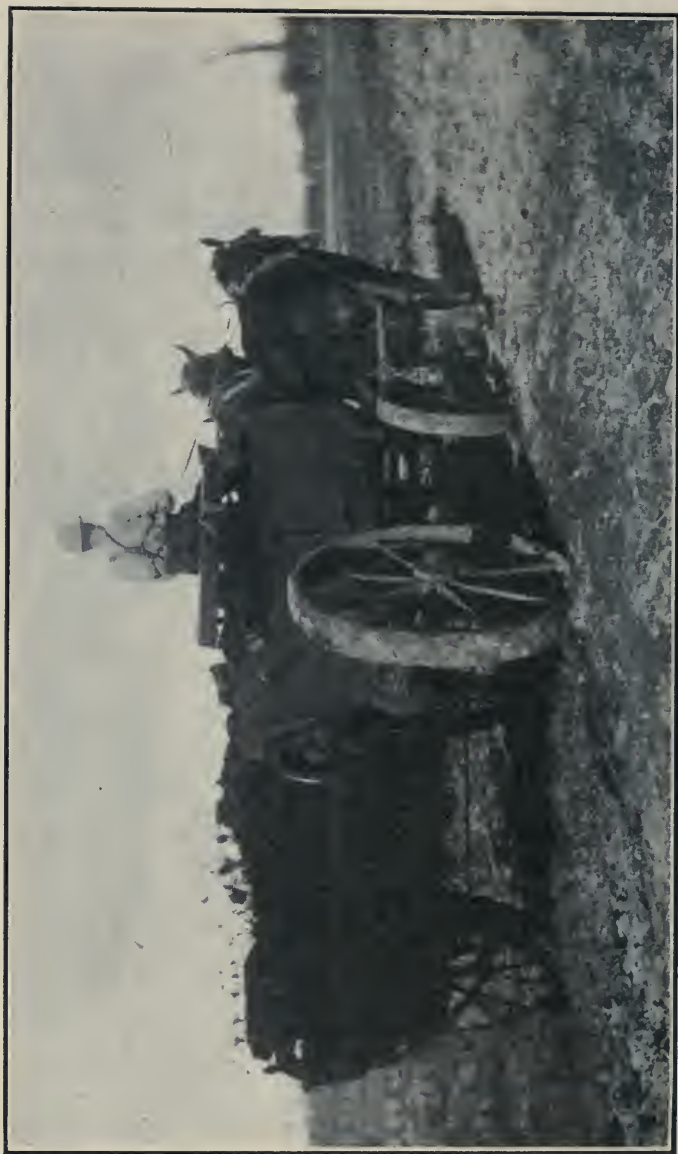

50. AN UP-TO-DATE MANURE SPREADER AT WORK.

be well rotted so as not to interfere with cultivating, which is preferable to plowing before sowing.

In order to pulverize the manure and spread it on the land evenly, so that it will not interfere with the cultivation or drilling in of the grain, it is advisable to use a manure spreader. *See Ill. 50.* This machine spreads the manure much more evenly than it can be done with a fork and does the work very much more quickly.

Manure
Spreader.

If the manure is not sufficiently rotted and interferes with the cultivator it should be gang-plowed

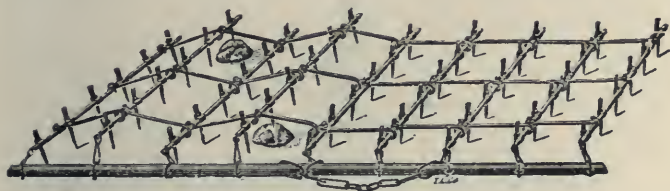

51. ADJUSTABLE SPIKE-TOOTH HARROW.

under shallow, then rolled and harrowed. If the subsoil is a tenacious clay it should be loosened with a subsoil plow (*see Ill. 9*) or a stiff-tooth cultivator (*see Ill. 48*). If the subsoil is very hard it may be necessary to cross cultivate in order to break up the subsoil to a depth of about ten inches before sowing. If the subsoil is sand or gravel, deep subsoiling is not necessary.

It is advisable to sow fall wheat with the grain drill to secure a uniform depth. Finish off with a spike-tooth harrow (*Ill. 51*) or a Breed weeder. This prevents water from lodging in the creases made by the grain spouts and freezing in winter, which is liable to injure the wheat plants. With the foregoing preparation a good wheat crop may be reason-

Sowing
Fall Wheat.

ably expected and a fair start made in a systematic rotation.

Increasing the
Fertility of the
Soil.

While the green crop and farmyard manure which has been prepared and worked into the surface soil will provide the necessary amount of vegetable matter and nitrogen for the wheat crop, provision should be made for increasing the fertility of the soil by seeding the fall wheat with clover to provide a further supply of vegetable matter and nitrogen (two essential elements of fertility). Three pounds of timothy seed may be sown with the fall wheat.



52. WHEELBARROW GRASS SEEDER.

Sowing
Timothy Seed.

Sow the timothy seed in front of the grain spouts so that it will be scattered between the rows of grain. If sown behind the grain spouts the timothy seed will fall in the creases with the grain and is liable to be choked out.

Sowing Clover
Seed.

Clovers require to be sown in the early spring with a grass seed sower (*see Ill. 52*) at the rate of about eight pounds of red clover and three pounds of alsike clover seed per acre.

Harrowing
Fall Wheat in
Spring.

After the clovers are sown and the land is dry it is an advantage to harrow across the rows of wheat

to pulverize the surface soil that will have formed a crust during winter.

Another method of preparing exhausted land for a systematic rotation is to plow the land shallow with either a single or two-furrow gang plow as soon as the crops are off in the early autumn, then roll and harrow immediately.

Restoring
Exhausted
Land.

In about ten days cultivate and harrow to encourage the growth of any weeds or weed seeds that may be in the soil. Cultivate a second time in about ten days with the wide points to cut off all weeds, then give a stroke with the harrows to shake the weeds out to dry.

Destroying
Weeds and
Weed Seeds.

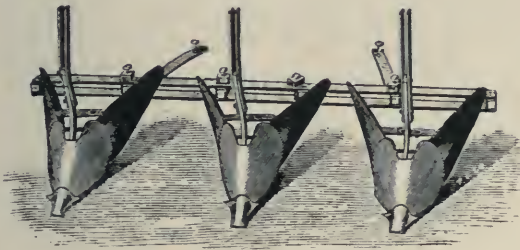

53. SET OF RIBBERS.

In October spread ten or twelve loads of farm-yard manure per acre as far as can be had, and cover same by ribbing the land with a single or double mould-board plow; or a still better method is to use a set of three "ribbers" (*Ill.* 53) attached either to the frame of a spring-tooth cultivator or a stiff-tooth subsoiler.

Manuring and
Ribbing.

With this implement one man and three horses can rib seven or eight acres per day. With five ribbers and four horses ten acres can be ribbed each day. Make ribs about twenty inches wide so that

Gang or Rib-
bers on Sub-
soiler Frame.

they may be easily levelled down in spring by harrowing and cultivating. Land prepared in this manner will be in the best possible condition for early spring sowing.

Eyes of Weeds
are Near the
Surface.

All the buds or eyes on thistle roots and other perennial weeds are near the surface of the ground, and the roots that run down deep into the subsoil are only feeders and have no buds or eyes to start a new plant.

Deep Plowing
Transplants
Perennial
Weeds.

By plowing say seven inches deep all the buds are left in the furrow and will sprout and grow quickly—several plants from each root. Thus, in many cases, deep plowing multiplies the plants instead of reducing their number.

Plowing Down
Weed Seeds
Pollutes the
Soil.

Plowing down weed seeds is ruinous to the land, as many varieties of weed seeds will, if excluded from the air, retain their vitality in the soil for fifteen and twenty years

CHAPTER IX.

DESTROYING WEEDS.

The correct method to adopt for increasing soil fertility and ridding the soil of weeds and weed seeds, both annual and perennial, is shallow plowing and thorough cultivation early in the autumn, using the wide points on the cultivator and harrowing alternately.

To Clean the Land from Weeds and Weed Seeds.

All seeds near the surface will germinate and grow quickly and the roots of perennials will send up shoots. The simplest method of exterminating these is to cut them off below the surface when about three inches high or before the leaves are fully developed.

Hasten Germination.

This work can be done expeditiously with either a spring or stiff-tooth cultivator with wide points regulated to cut two or three inches below the surface. *See Ills. 47 and 48.*

Best Implement to Use.

When the weed plants are growing they derive their nourishment from the soil through the roots, but after the leaves are fully developed they collect a certain amount of nutriment from the atmosphere. Care should, therefore, be taken that they are cut down before the leaves are developed. After the land has been cultivated and harrowed in the manner described, a hot summer sun will kill all the weeds thus cut off.

When to Cultivate.

If this operation is repeated at intervals of two weeks until September, the land will be quite cleared of all perennial weeds and annual foul seeds that were on or near the surface. When land has been treated in the manner described in the foregoing paragraphs it will be in good condition to grow a grain crop of any kind.

Cultivate and Harrow at Intervals.

Manure and
Rib for Spring
Grain.

If it is decided to sow grain in the spring, instead of fall wheat, coarser manure may be spread over the surface and ribbed in October with a double mould-board, plow, or ribbing attachment on a cultivator frame.

Ribbing
Preserves
Plant Food.

Ribbing prevents the soluble plant food from leaching away during the winter. When the land is "ribbed" the rains and melting snows run off in the furrows without interfering with the manure and humus which are preserved in the centre of the ribs. Make the ribs about twenty inches wide. When land is ribbed in the fall it allows the frost to break up the subsoil and loosen it. Run across furrows wherever necessary to carry off all surface water and make proper outlets for same, so that there will be no pools of water standing on the land intended for seeding.

Spring
Cultivation.

In the spring, if the subsoil is a sandy loam, the ribs are harrowed and cultivated down with a spring-tooth cultivator; if the subsoil is clay it will be necessary to use the stiff-tooth subsoiler to loosen the subsoil ten inches deep. The ground should be harrowed before the grain drill is used.

Advantages of
Ribbing.

Grain crops, such as wheat, oats or barley, should be sown as early in the spring as possible. When the land has been ribbed and cross furrowed in the fall it is in a fit state for seeding very much earlier than land which has not been ribbed.

Ribbing North
and South.

An advantage is gained by running the ribs north and south, so that the sun will shine into the furrows and dry out both sides of the ribs.

Quality of
Seed Grain.

Use only sound and well matured grain for seed. When every kernel is fully developed and the land in a high state of cultivation, the following quantities are quite sufficient per acre: Barley, one and one-half bushels; wheat and oats, one and one-quarter bushels.

The best method of sowing clover and timothy seed with grain, when the grain drill is used, is to sow the clover and timothy in front of the grain spouts, or tubes, so that it will be scattered on the surface. After sowing, give a stroke with the harrows or Breed weeder crossways to smooth the surface. - *See Ill. 66.*

Sowing Clover and Timothy.

Do not roll until the land is thoroughly dry, even if by that time the grain is two or three inches high. If the land is rolled in the early spring when it is damp, a crust is liable to form which will encourage capillary attraction and so cause the moisture in the soil to rise to the surface and become evaporated. Rolling after the land has been thoroughly dried prevents this, as the lumps of earth on the surface are then pulverized, thus forming a mulch which prevents evaporation.

When to Roll.

To further increase the humus in the soil cut the clover early the following year for hay, say about the middle of June. When the second growth is coming into bloom, plow under about four inches deep, using a revolving coulter and chain as before described. Roll, and harrow thoroughly.

How to Increase Fertility and Eradicate Weeds.

In about two weeks the sod will be sufficiently rotted to cultivate with a spring-tooth cultivator. By cultivating several times with wide points, and harrowing alternately during the summer and early fall, all weeds and weed seeds should be destroyed.

Sod will Rot in Two Weeks.

In the autumn, spread over the surface ten or twelve loads of farmyard manure per acre and rib as before described. In the spring, when the ribs have been levelled down, the manure and rotted clover sod will have become thoroughly incorporated, making the very best quality of vegetable matter for growing crops of all kinds. Land treated in this manner will be in good condition to grow abundant crops continuously, provided a systematic rotation of crops is followed.

Manure and Rib.

CHAPTER X.

ROTATION OF CROPS.

To secure the best results from the farm, certain principles must be adhered to in order that the fertility of the soil may not only be retained but increased, and that at the least possible cost. In order to do this one of the first steps to be taken is to adopt a system of rotation which will be best suited to the circumstances. Location must be considered as well as the kinds of soil and the number and kinds of animals to be provided for.

Clover and
Farmyard
Manure.

It is essential that a crop of clover sod be plowed under every three or four years, in addition to all the manure made on the farm, in order to supply the amount of vegetable matter required for the proper growth of cereal and other crops.

Make Vege-
table Matter
Available.

It is not only necessary to fill the soil with vegetable and animal matter, but these must be made available for plant food before the crops can derive any benefit from them. This is accomplished by thorough cultivation in warm weather, as vegetable matter will not decompose when cold.

A Four Years'
Course.

The following rotation is the best for mixed farming, and was followed with marked success by the writer for a number of years on his own farm, and during the six years he was farm superintendent at the Ontario Agricultural College.

Dividing Farm
into Sections.

The farm proper is divided into four sections (*see Diagram 54*) instead of many small fields, as is the usual custom, and is cropped as follows:—

First and second years (Nos. 1 and 2 sections), grass, including hay and pasture; third year (No. 3

section), hoe crops—corn for silage, rape, potatoes, mangel wurzel, etc., the balance in peas; fourth year (No. 4 section), grain, cereal crops, such as wheat, barley and oats, all of which should be seeded down with the following mixture: Red clover seed, seven pounds; alsike clover seed, three pounds; timothy seed, four pounds per acre, mixed.

In this four years' rotation several variations may be made. If more grain is required and less meadow and pasture, a portion of No. 2 section may be plowed shallow after the grass is cut, or pastured, early in August, then rolled and harrowed immediately.

Variation of
Rotation to
Meet
Requirements.

The harrowing should be done thoroughly, as it is by having a fine tilth on the surface that moisture is conserved in dry weather, and this is one of the most important essentials in rotting sod quickly.

Harrow Sod
Thoroughly to
Conserve
Moisture.

Many farmers do not appear to understand the proper mode of harrowing; when harrowing twice in a place they invariably return in the same track instead of half-lapping so that all the land may be harrowed evenly.

Harrowing-
Half-Lapping.

The three essentials to decompose vegetable matter quickly and form humus are heat, air and moisture, and these are supplied by plowing in July and August when the weather is warm for heat, shallow plowing will let in the air, and the moisture can be conserved in the sod by first compacting it with a heavy roller, thus drawing the moisture from below by capillary attraction, then harrowing to prevent evaporation from the surface.

How to Rot
Sod Quickly.

Under this treatment sod will rot quickly, and, if cultivated with the wide points on the cultivator, and harrowed alternately until the fall, the land will be cleaned of weeds, and a large amount of plant food will be made available for fall wheat or spring grain.

Cultivate and
Harrow
Alternately.

HOW TO RESTORE & MAINTAIN SOIL FERTILITY, SYSTEMATIC ROTATION OF CROPS, A FOUR YEARS COURSE

150 ACRE FARM.

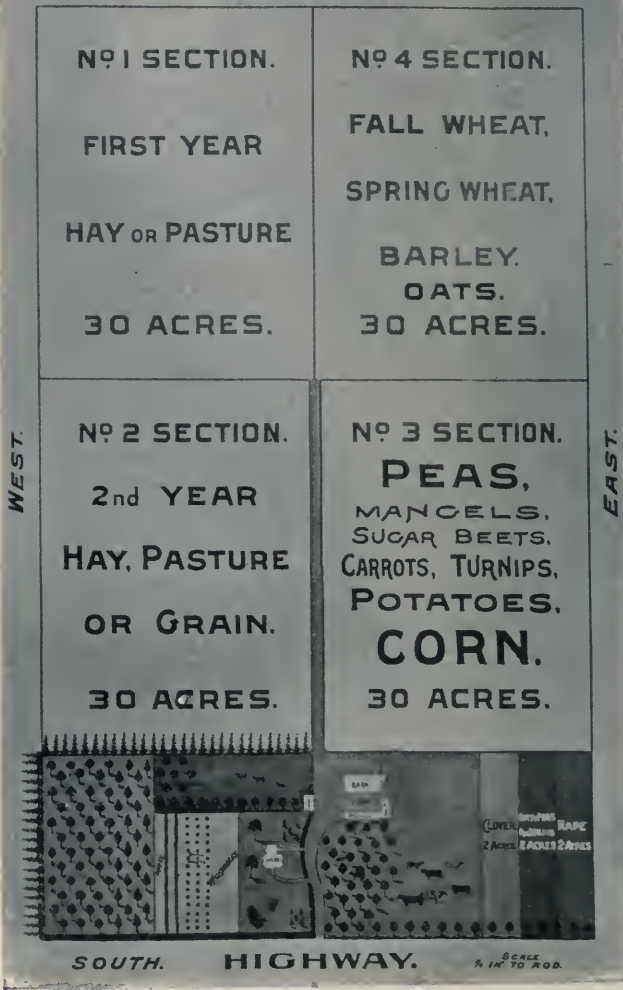

54. DIAGRAM OF FARM.

The following year the whole of No. 2 section, including the sod left from the previous year, and the stubble land, may be plowed with a two-furrow gang-plow (*Ill. 55*) by adding a third horse for the sod.

Plow Sod and
Stubble Land.

If the land is too dry and hard, use a single plow with wheel to regulate the depth (*Ill. 49*). By keeping the humus on the surface there will be no difficulty, after a few years, in plowing sod in the summer, as humus will not get hard. Hasten decomposition, as before described, by having the ground rolled and harrowed immediately after plowing.

Plowing in
Summer.

Early fall is the best time to clean the land of weeds and weed seeds for the next season's hoe crop, and with proper implements the work of fall cultivation can be done thoroughly while there is no crop on the ground. The broad-share cultivator and harrow should be kept going alternately at short intervals until October. By that time the land should be in fine tilth and free from weeds or weed seeds that may be near the surface.

Fall Cultivation
—Best Time to
Clean the Land.

All the farm manure that is on hand should be spread on the surface at the rate of about fifteen two-horse waggon loads per acre and covered by ribbing the land with the attachment (*see Ill. 53*) on the cultivator frame, making the ribs about twenty inches wide.

Manuring and
Ribbing Before
Winter.

The manure will then be in the centre of the ribs, which will prevent it from leaching and being lost. The decomposed vegetable matter in the ribs will act as an absorbent and prevent the liquid manure and ammonia from escaping.

Advantages of
Ribbing.

The furrows tend to drain the land and allow the frost to act on the subsoil. If the ribs are run north and south the land will dry several days

Ribbing North
and South.

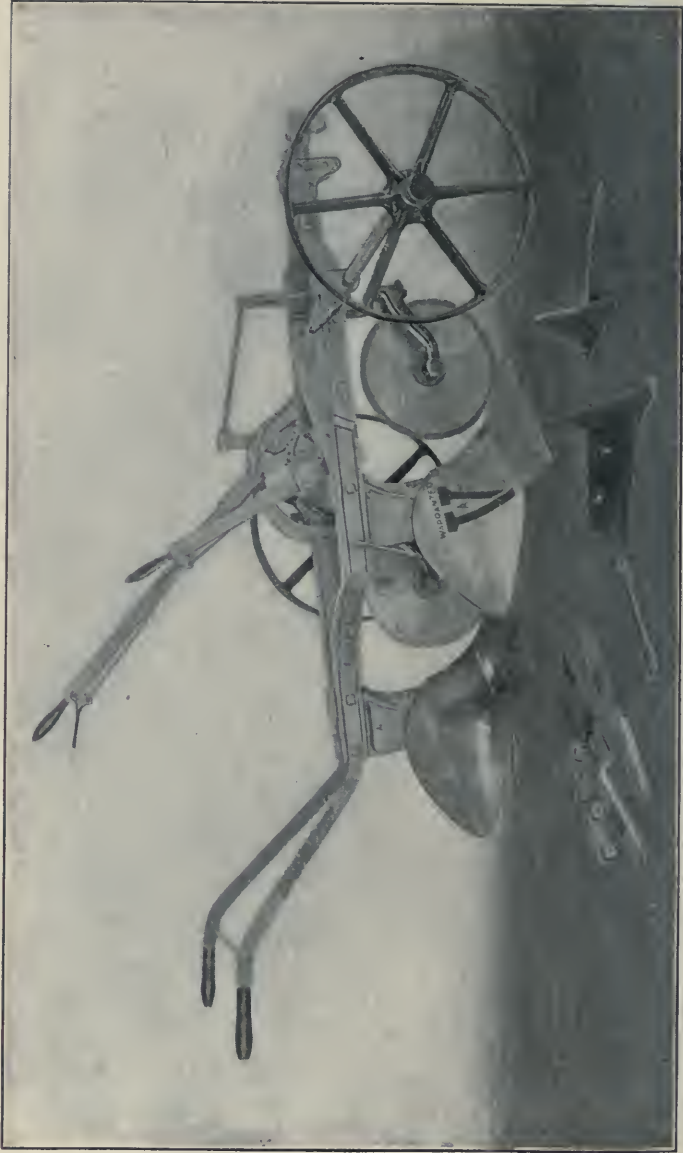

55. TWO-FURROW GANG PLOW.

sooner in spring. Cross furrows must be run wherever necessary to carry off all surface water.

If there is not sufficient manure on hand in the fall to cover the whole of this section, the portion that is left without manure should not be ribbed, so that it can be manured on the surface during the winter. In spreading manure in the winter, when the ground is frozen, double the usual quantity should be put on the knolls or small hills, as a certain portion will leach to the lower land.

Manuring in Winter.

In the event of weed seeds being in the green manure it is advisable to stack it in the barn yard, from winter until autumn, in order to destroy all seeds. There is little loss of fertility where the following method is adopted: Make a heap thirty or more feet square; keep the sides plumb; mix all the manure made on the farm; should be six or eight feet high. This will make a valuable compost heap. All the rainfall on this small surface will be absorbed in the manure. Keep the top level.

Stacking Green Manure.

On rolling land it is advisable to manure and rib in the fall, so that all the liquid in the manure will be absorbed in the rotted sod contained in the ribs. This completes the fall work on section No. 2, which is to be followed with a hoe crop in section No. 3.

Manure and Rib Rolling Land.

After making due allowance for the hoe crops, including corn, rape, turnips, potatoes, mangel wurzels, etc., in this section, the balance is sown with peas, the highest portion of the section preferred, as a pea crop is usually followed with fall wheat. If this sod land was thoroughly cultivated the previous autumn, manured and ribbed, in the spring these ribs will require to be levelled down by cultivating, harrowing and subsoiling ten inches deep. This will keep the soil dry and warm—a very desirable condition for growing peas.

High Land for Peas.

Preparation for
Field Roots and
Other Hoe
Crops.

The portion of land intended for mangel-wurzels, sugar beets and carrots should be prepared by thorough cultivation, manuring and ribbing according to the foregoing directions so that the soil will be in good condition for early cultivation in the spring. It is important that those seeds be sown early in the spring, about the end of April or early in May. Farm manure as a rule should be applied previous to the hoe crops, as it promotes rank growth, which is desirable for fodder corn and roots.

Advantage of
Sowing Peas
with the Grain
Drill.

It is advisable to sow the peas with an ordinary grain drill (*Ill.* 56), which will plant the seed at a uniform depth and so ensure the plants making an equal start. If the seeds are not planted at a uniform depth, the crop returns become a question of the survival of the fittest, the rank, luxuriant plants choking out the others.

Depth to Plant
Seeds.

As to the depth to plant peas, in all seeds, a good rule to follow is to plant to a depth of four or five times the diameter of the seed. Two to three and a half bushels should be sown to the acre, according to the size of the peas. As peas are large and do not stool from the root like other grain, it is necessary to sow them more thickly.

CHAPTER XI.

GRAIN GROWING.

Peas should be harvested before they are quite ripe, as the straw of peas is of exceptional value for feeding to animals, rating next to clover hay, which is the highest in nutritive value of all fodders. The

Harvesting
Peas.

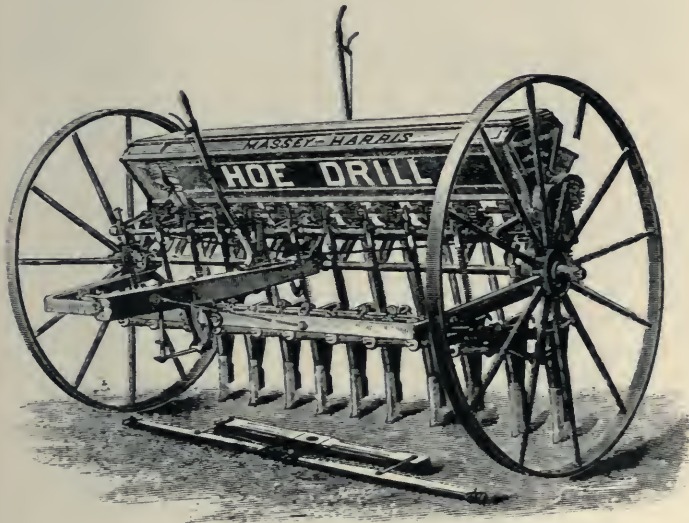

56. GRAIN DRILL.

most satisfactory implement for harvesting peas is the "pea harvester" with bunching attachment, which can be attached to any mowing machine (Ill. 57). The peas should be drawn into the barn soon after being cut, say within one or two days. A shower of rain will do much harm to the straw, and long exposure to the sun will make the straw brittle and unfit for fodder.

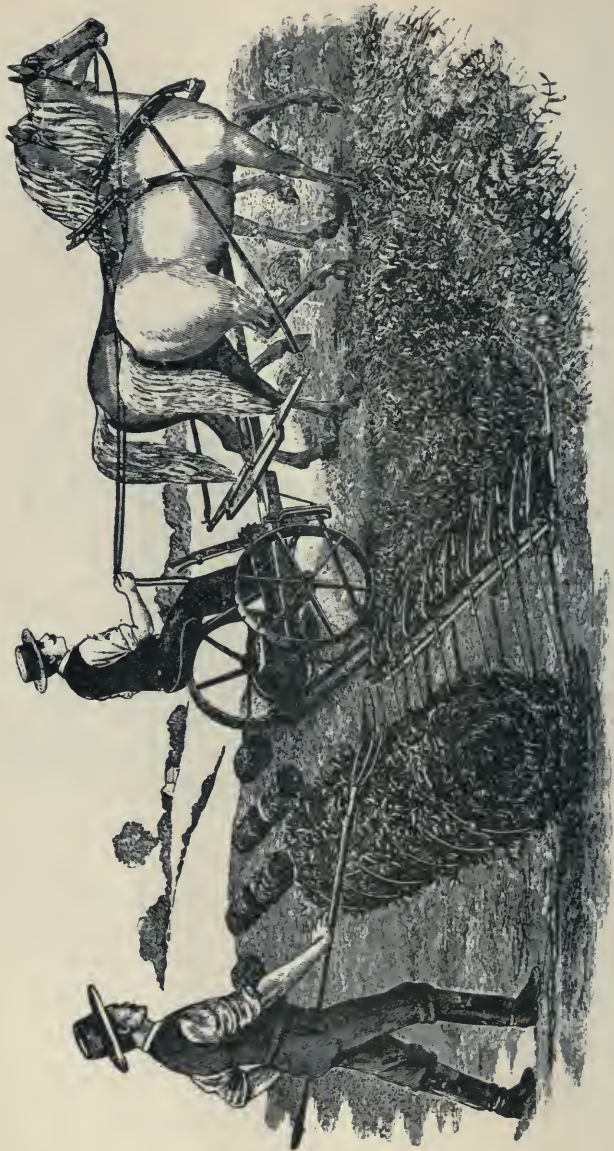

57. TOLTON PEA HARVESTER.

Peas may be successfully threshed with the ordinary threshing machine by placing pulleys on each end of the cylinder shaft double the circumference of those ordinarily used. This will run the cylinder at half speed, while the rest of the machinery is on full speed. Take all the spikes out of the concave except four.

Threshing Peas.

Because of the prevalence of the pea bug, or weevil, many farmers have given up trying to grow this valuable crop. In sections of the country where the pea bug prevails, the seed should be treated with carbon bisulphide to destroy the bugs. This should be done early in the fall while the insects are in the embryo state and before they have done any material injury to the peas.

How to Destroy the Pea Bug.

The following method of treatment is very effective and easily followed. Use an air-tight box that will hold ten or twenty bushels. Fill the box with peas and set a dish on top of the peas containing one pound of carbon bisulphide, which is sufficient to treat fifteen bushels, close the lid, making it as air-tight as possible, and leave for three days. At the end of the three days the carbon bisulphide will have evaporated and penetrated all the peas in the box, completely destroying the insect germs that are in the peas without injuring the peas. Care should be taken to keep away any flame, as the material is very inflammable. If all the farmers in a neighborhood would unite and treat their peas, it would not be necessary to repeat this every year.

Method of Treatment.

As soon as the peas are taken off the land should be plowed shallow with the two-furrow plow, rolled, and immediately harrowed; cultivated and harrowed alternately until it is time to sow the fall wheat.

Cultivation of Pea Land for Fall Wheat.

The rotted sod, farm manure and pea stubble will supply the nitrogen and other elements neces-

Elements of Fertility.

sary for the healthy growth of a crop of fall wheat or any other grain crop.

**Subsoiling
Clay Land.**

Before the fall wheat is sown the land should be subsoiled nine or ten inches deep with four horses on the subsoiler (*Ill. 1*), unless the subsoil is of a sandy or porous nature. Harrow before and after sowing.

**Time to Sow
Fall Wheat.**

For Central and Northern Ontario the time to sow fall wheat is the end of August or beginning of September. In Southern Ontario the seed should be sown from the tenth to the fifteenth of September.

**Quantity to
Sow.**

Sow fall wheat with the grain drill at the rate of one and a quarter bushels per acre, using only good, clean and thoroughly matured seed.

**How to Destroy
Smut Spores.**

The seed should, before sowing, be treated with formalin if it shows any traces of smut. A simple and effective method is to make a solution in the proportions of half a pint of formalin to ten gallons of water. This is sufficient for twenty-five or thirty bushels of wheat. Having prepared the solution, spread the wheat on the floor and sprinkle the formalin solution over it with a watering can; the wheat should be shovelled over while being sprinkled, so that every grain will receive a portion of the solution. After sprinkling, dust the wheat over with slaked lime so that it may be sown with the grain drill.

**Prevent
Heating.**

Do not put the grain into bags many hours before sowing, as this will cause it to heat and seriously injure its vitality. Every germ of smut must be destroyed, otherwise it will develop and produce smut the following year.

**Smut Spores
Feed on Plant.**

It has been proved by botanists that the smut spores cling to the kernel and when it germinates the spores feed on the plant, finishing with the grain,

so that the kernels become smut instead of grain. These same principles hold good with oats and barley.

While it is important to have the soil and other conditions as favorable as possible, the best results cannot be obtained unless a variety of grain is sown that will give the largest yield and the best quality. The sowing of a productive variety will make all the difference between profit and loss.

Sow the Most Productive Varieties of Grain.

Every farmer who has had experience in the growing of wheat will remember varieties which excelled all others for some years but had to give place to something new (often being self-hybridized). There is no doubt that grain would not depreciate so rapidly if only the best grains were sown each year. Indeed, in many cases the same variety has been used on the same farm year after year with ever improving returns.

Hybridize Varieties.

It is well to note that in order to obtain the best results the land must be in good condition and the grain sown must be carefully selected, both for productiveness and milling qualities.

Results from Good Cultivation and Seed.

Wheat should be cut when the grain is in the firm dough state, as according to analysis this produces the finest quality of flour. With the improved harvesting machinery of the present time there is no excuse for allowing the grain to become over-ripe before it is cut.

When to Cut Wheat.

The only harvesting machine in the early part of the last century was the sickle; after this came the scythe with the bow, followed later by the grain cradle, after which a crude style of reaping machine was brought into use. Several inventions followed, but with all of them a man had to put the grain off the platform with a fork or rake. The next improvement was the "self-raker."

Improvements in Harvesting Methods.



58. SELF-BINDER AT WORK IN AN OAT FIELD.

Following it was the "Marsh Harvester," on which two men rode and bound the grain as it was elevated. To-day we have the wide-cut self-binder complete (*Ill.* 58), a machine that will bind and cut the heaviest crop of grain and do the work in the most perfect manner.

Marsh-Harvester Principle of Elevating Used To-day.

In setting up grain to dry, the long "shock" or "stook" is preferable (*Ill.* 59). The sheaves are set up firmly in pairs, ten or twelve in a shock. The shock should stand with ends facing north and south, so that both sides will be exposed evenly to the sun. Wheat should stand a week in the field after being cut, so that it may dry out thoroughly and the grain become hard.

How to "Shock" Grain.

As previously shown, great progress has been made towards perfecting harvesting machinery. An equal advance has been made in threshing machines. In the early days of this country all the grain was threshed with the flail or trodden out by oxen or horses on a floor.

Improvements to Threshing Machines.

In the writer's younger days he has threshed all winter with the flail, from the time the land froze up in the fall until seed time in the spring. The first implement in the shape of a threshing machine was simply a cylinder set in a frame with beaters instead of spikes, and the grain had to be separated from the chaff with a simple hand fanner.

Writer's Early Experience in Threshing.

Later there was a succession of improvements, until now we have the self-feeding thresher and separator that will thresh and clean the grain ready for market, and do the work as fast as two men can fork the sheaves into it. *See Ill.* 60.

The Modern Thresher.

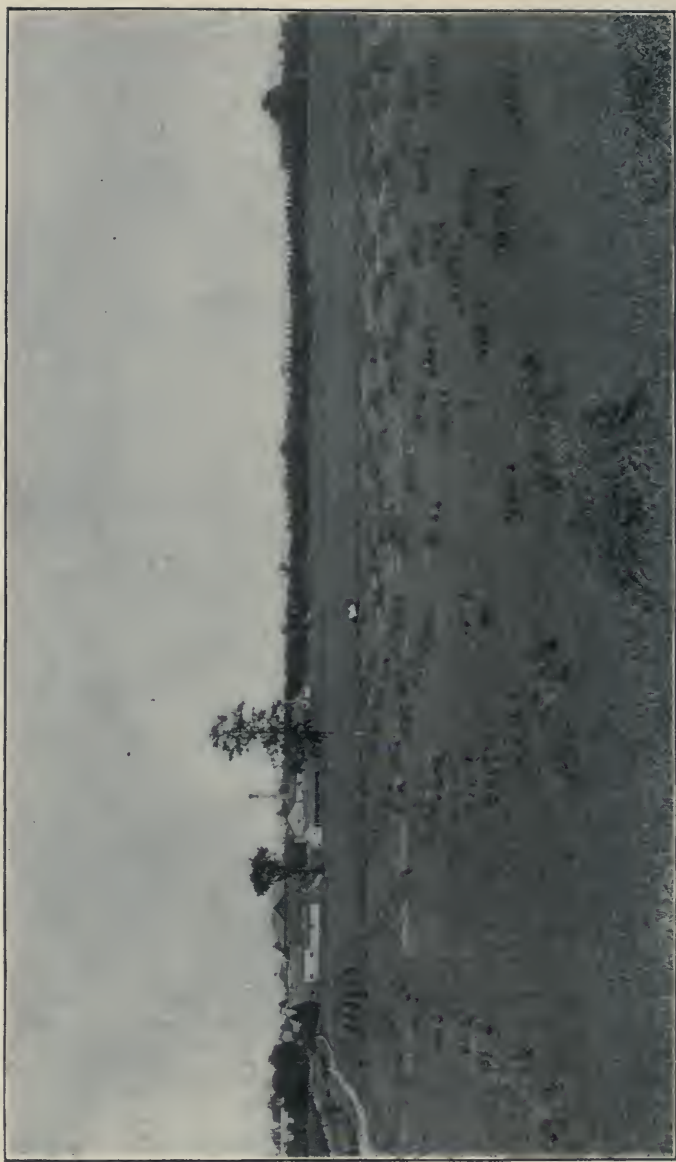

59. OATS IN LONG SHOCKS.

CHAPTER XII.

FIELD ROOT CROPS.

Sod land that has been plowed shallow in the early autumn and thoroughly prepared according to previous directions, also manured and ribbed, is in the most desirable condition for root crops, especially mangels, sugar beets and carrots, that require to be sown as early in the spring as the soil is sufficiently dry and in fine tilth. The first operation in spring is the levelling of the ribs by harrowing and cultivating. If the soil is of a sandy and porous nature, five or six inches will be sufficiently deep to cultivate, but clay soil should be loosened ten inches deep with the subsoiler (*Ill. 1*), cultivating both ways (crossing) to loosen the subsoil, so that all rain water will percolate into the subsoil and allow the air free access into the soil to warm it and assist the bacteria to act on the vegetable matter and make it available for plant food. Another object in loosening clay soil is to allow the rootlets of deep-rooted plants free access to feed on the mineral matter contained in the subsoil. When roots are fed on the farm the quality of the farmyard manure is improved very materially for growing succeeding crops.

After subsoiling, harrow and cultivate until there is a fine tilth; then roll if dry. While good results are produced from sowing on the level, still the writer prefers shallow drills, which are made with a double mould-board drill plow with marker (*see Ill. 13*), so that the drills are of equal width. This is an advantage for horse hoeing. Drills for all root crops, including potatoes, can be made with

Spring Cultiva-
tion for Hoe
Crops.

Shallow Drills,
Made with
Ribbers on the
Stiff Tooth
Subsoiler
Frame.

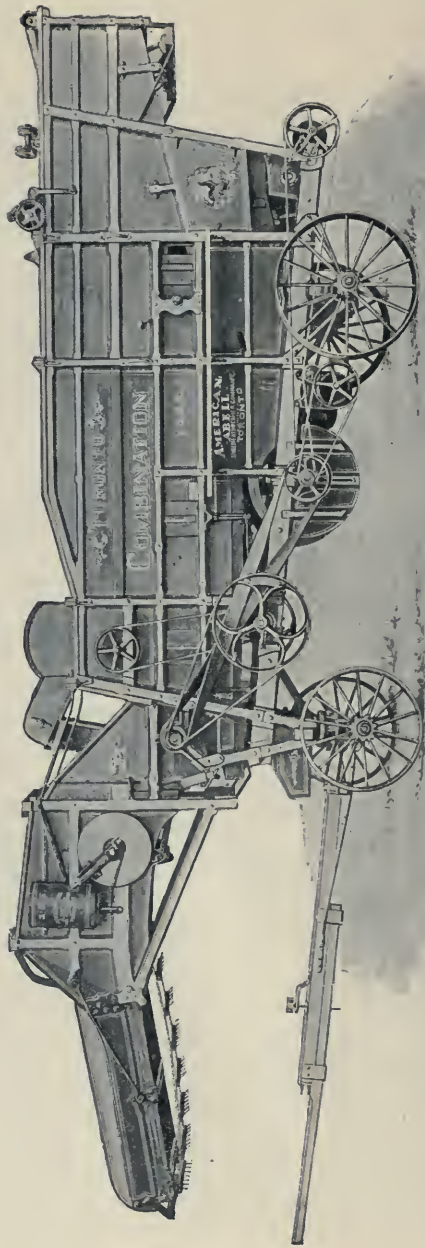

60. MODERN THRESHING MACHINE.

three ribbers attached to the frame of the stiff-tooth subsoiler. This effects a great saving in labor. One difficulty in using the ribbing attachment for making drills for hoe crops is in keeping them straight and even, which is important to the proper regulation of the horse hoe (scuffler). *See Ill. 63.* This may be overcome by uncoupling the pole at the castor wheel, and instead of the horses guiding the drillers they are kept in place by the use of a lever. *See Ill. 61.* This is a very useful implement. It is first a subsoiler, second a stiff-tooth cultivator, third a spring-tooth cultivator, fourth a ribber, fifth a driller for making drills for mangels, turnips, etc., also for opening drills for potatoes and covering same three drills at a time.

In making drills, have the mould-boards set wide, so that the furrows will meet at the top, without going deep, as the composition of the drills should mainly be rotted sod and farm manure, which makes a complete composition for growing roots and corn. The drills for mangel-wurzels and other field roots should be twenty-eight or thirty inches wide. The quantity of mangel-wurzels and sugar-beet seed advisable to sow is four pounds per acre. Less seed will do, but in order that there should be no blank spaces it is better to sow plenty of seed. With carrots, three pounds per acre is quite sufficient.

As soon as the drills become dry after sowing, roll them with a heavy land roller. This will assist capillary action, so that the moisture from below will rise to the surface. Then, to prevent evaporation, the surface must be loosened. A very satisfactory implement for this work is the Breed weeder, which will cover four drills. It is advisable to raise the two teeth (about two inches) which come in the centre of each drill, so that the seed

Making Drills,
and Sowing
Field Roots.

Cultivation
After Sowing to
Cause Soluble
Plant Food.

will not be disturbed. This is done by putting a thin piece of wood—say two laths—under these teeth and over the others about the centre of the teeth. There are several advantages to be gained by keeping the surface loosened even before the plants appear above the ground. The air is thus let into the soil and moisture is conserved. Bacteria

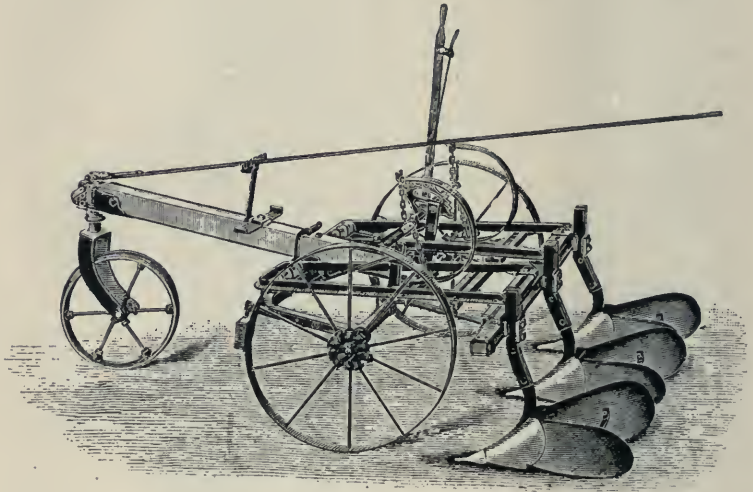

61. CULTIVATOR FRAME WITH RIBBERS.

is also thereby allowed to act on the humus, and make it available for plant food, so that as soon as the plants commence to grow they are provided with a full supply of soluble food.

Thinning, and
Varieties of
Field Roots.

Commence thinning mangel-wurzels when the plants are from one inch to one and a half inches high, leaving the plants about twelve inches apart in the row. It is scarcely ever necessary to stoop and use the fingers. The work can be done with the

hoe that is made for the purpose *See Ill. 62.* This hoe should be kept quite sharp and square at the corners. The operator walks at the side of the drill and draws the soil on the near side and pushes the soil at the far side, and with the corner of hoe cuts out unnecessary plants, leaving only one plant in a place. A man who understands how to do this work properly will hoe and leave in good shape half an acre per day. Carrots take more time, as they require to be left closer, not more than eight to ten inches apart. The Breed weeder is the only implement required until the plants are from two to three

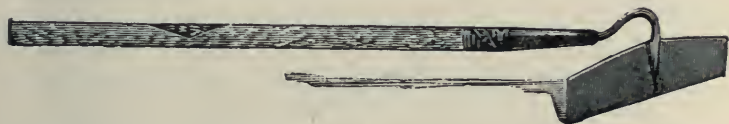

62. TURNIP HOE.

inches high; then the "horse hoe" (*see Ill. 63*) should be used frequently during the growing season. On no account should a crust be allowed to form on the surface. For breaking up the crust the combined harrow, cultivator and pulverizer is a satisfactory implement. *See Ill. 14.* All root crops should be cultivated on the level. Even potatoes should not be hilled up when growing, as this throws the rain water from the plants.

The mammoth long red variety of mangel-wurzel, as a rule, is the heaviest cropper. The giant yellow intermediate is a close rival. These will average, under favorable conditions, thirty tons per acre. It is generally supposed that the yellow mangels are the most nutritious, but, according to analysis, there is very little difference. The sugar mangel is the richest of all. One objection to the

Varieties of
Mangels,
Sugar-Beets
and Carrots.

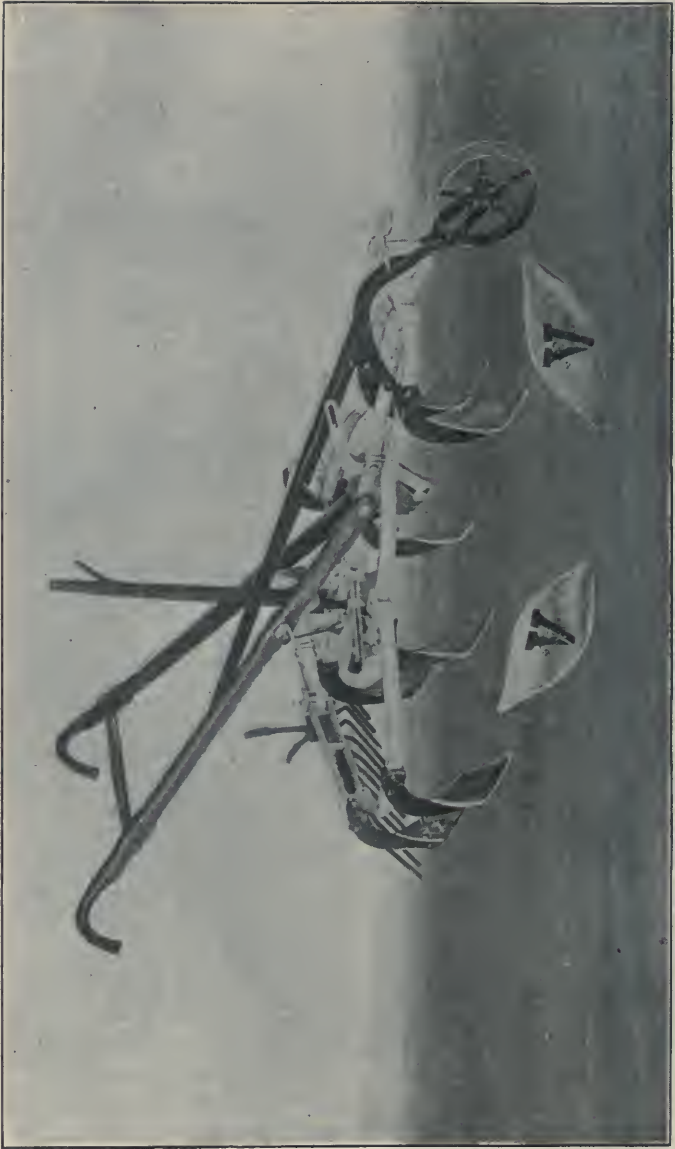

63. HORSE HOE OR SCUFFLER.

long red is that when harvesting and putting in the cellar many of them are broken, which injures their keeping qualities. The broken or bruised roots should be fed first. The best variety of sugar-beet for farm purposes is the giant variety. It is a heavy cropper, one which will average under favorable conditions between twenty-five and thirty tons per acre. It stands well out of the ground, so that it is easily harvested. Sugar-beets are more nutritious than any other field root, and will keep longer.

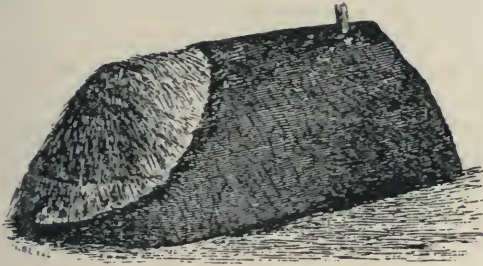

64. STORING ROOTS IN PIT.

In Central and Northern Ontario the time to harvest mangel-wurzels and sugar-beets is from the fifteenth to the twenty-fifth of October. When pulling, it is preferable to twist the tops off by hand, as when topped with a knife they are more liable to decay. For convenience in loading into the waggon, throw four drills into a row, providing there is no danger of frost; allow them to remain on the ground for twenty-four hours after being pulled and topped, as this will improve their keeping quality. If there is any indication of frost they should be either housed or covered every night, as three or four degrees of frost will injure mangel-wurzels and sugar-beets after they are pulled.

**When and How
to Harvest
Field Roots.**

Storing and
Ventilating
Field Roots.

When putting roots into a cellar it is advisable to run them over a slatted chute, so as to riddle out the earth. No tops should remain on the roots, as they will soon decay and injure the roots. Where the roots drop into the cellar they are liable to heat unless an opening is made (funnel-shaped) nearly to the bottom. There are two important matters in connection with the successful storing of roots. The first is to keep them sufficiently cool; the second to prevent them from freezing. To accomplish this, stone or cement basements underneath barns should be sheeted on the inside of wall, and also sheeted overhead or under the upper floor. The principle of ventilation in a root cellar is the same as that required to cause a draught in a stove. The openings above are useless without small openings below, similar to a damper in the front of a stove. For this purpose a number of small drain tiles should be put in the bottom of wall next to cattle stable, and near to the top of the wall have large openings, which should remain open all winter. The outside windows should be kept open every day until the winter sets in—say the beginning of December. About the 25th of December it will be necessary to bank up the windows with stable manure to keep out the frost.

Pitting, Cover-
ing and Venti-
lating Roots.

When there is not sufficient cellar room the balance of the roots may be pitted successfully. Mark out pit of the required length, about six feet wide, and excavate three or four inches. The earth should be laid along the sides. Dumping carts are move convenient than waggons for unloading roots into pits. Build the roots up to a point four or five feet high (*see Ill. 64*), then cover with straw about three inches, and with earth six inches. This covering is sufficient until the end of November, then re-

cover with an addition of three inches of straw and twelve inches of earth. In order to get sufficient mould it is advisable to plow around the pits a number of furrows not exceeding nine inches in depth, as the surface soil which is composed of vegetable matter is more impervious to frost than clay. To make provision against excessive frost it is advisable to cover pits, the last of December, with stable manure to the depth of about ten inches. To ventilate a pit set three-inch drain tiles on top, with one end resting on the roots. Place about eight feet apart near the bottom of the pit, two-inch tiles, so as to cause a draught. Fill the tiles with straw in December.

For field culture the white intermediate carrot is unquestionably the most profitable variety for the farmer to grow for feeding purposes. The nutritive value is equal to any of the white varieties, and it is much more easily harvested than the others. Under favorable conditions this carrot will yield from twenty-five to thirty tons per acre. The cultivation of carrots is similar to that for mangel-wurzels and sugar-beets, with the exception of thinning. The carrot plants should be from eight to ten inches apart in the row. The time to harvest is the last week in October. In harvesting, the tops can be readily taken off with an ordinary hoe, while the roots are still in the ground. Then, with an iron plow without the mould-board, or a subsoil plow (*see Ill. 9*), the roots can be turned out. The plow should be run only sufficiently deep that the share will cut the points off the roots. This work may be done first and topping done afterwards with a knife. A very little frost will injure them after being pulled, so that it will be necessary to cover them at night if there is any danger of frost. Car-

Varieties, Cultivation and Harvesting of Carrots.

rots are grown chiefly for feeding to horses and milch cows, but for cows the Jumbo sugar-beet is taking the place of the white carrot, on account of the saving in labor in hand-hoeing and thinning. Horses are also as fond of sugar-beets as carrots, and the sugar-beets are quite as nutritious. The same method of keeping mangel-wurzels and sugar-beets during the winter is required for the keeping of carrots.

Swede Turnips,
Improved
Varieties.

There are many varieties of swede turnips grown at the present time. These have been improved from the original "Skirving," work which is carried on extensively by growers of swedes. The type of a root is fixed by growing seed from a certain type for a number of years. While some of the newer varieties are large and smooth, their quality for table use may not be equal to that of some others. As a rule, the bronze top varieties are superior to the purple top for table use. In some sections of the country the practice of growing swede turnips for export to the United States for table use has become quite an extensive business. The wisdom of doing this is another matter, for, aside from the ready cash derived, we must consider the fact that it takes about double the nutriment from the soil to produce a crop of turnips than it does for a grain crop. Again, the farmer should consider the great loss of fertility to the soil by selling and shipping the whole product instead of feeding it on the farm and returning it again to the soil, as only a small percentage is retained by the animals for the production of beef or milk.

Preparation of
the Soil for
Swede Turnips.

In preparing soil the previous fall for swede turnips, while it is preferable to have the land manured and ribbed, it is not so important, as turnips do not require to be sown as early as mangel-

wurzels, sugar-beets and carrots. It is advisable to have swedes follow a clover sod which has been thoroughly decomposed and which has been manured in the fall or during the winter with about fifteen waggon loads of farm manure per acre, thoroughly incorporated with the surface soil. Before making the drills, if the subsoil is clay it should be loosened about ten inches deep with a subsoiler (III. 1).

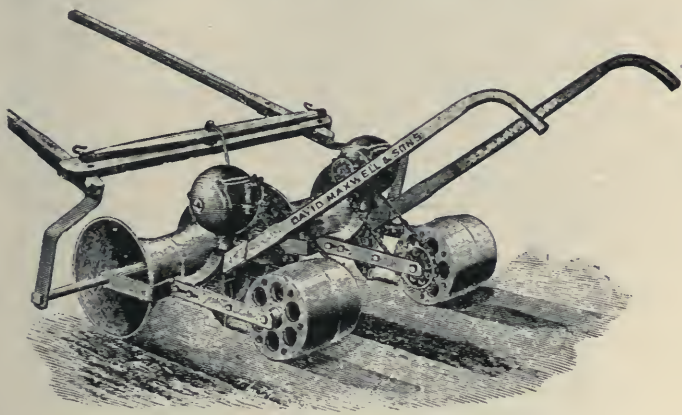

65. HORSE DRILL FOR SOWING FIELD ROOT SEEDS.

In order to do the work thoroughly it is advisable to first set the subsoiler eight inches deep, then across about two inches deeper. This method is most thorough. The next proceeding is to harrow and roll the land before making the drills, which are made the same as for mangel-wurzels, shallow, and twenty-eight or thirty inches wide. The time to sow swedes is from fifteenth to the twenty-fifth of June. If sown earlier they are liable to be more woody and are subject to the turnip louse (*aphis*).

The quantity of seed necessary is from two to

Quantity of
Seed per Acre,
and Conserving
Moisture.

three pounds per acre, and is best sown with the ordinary horse seed drill. *See Ill. 65.* In twenty-four hours, if the drills are dry, roll them down with a heavy roller, so as to hasten capillary action, and, as with mangel-wurzels, pulverize the surface to conserve moisture. If the surface is kept pulverized with a Breed weeder there will be no difficulty in getting a catch, even if there is no rain. Thin the same as mangels, with a turnip hoe. This work should be done early, while the plants are in the second rough leaf. To secure best results, level and thorough cultivation should be continued during the growing season.

Fall Turnips,
for Early
Feeding.

There are many varieties of fall turnips, and while their nutritive value is not equal to the swede, yet they have certain qualifications that recommend them. Some, being more rapid growers, can be sown later, as a catch crop, after a crop of early potatoes or on clover sod. The last of June or the early part of July is not too late for some of these. They should be sown in shallow drills, and cultivated and harvested in the same manner as swedes for early feeding. Some farmers prefer to sow them on the level, using an ordinary grain drill, each alternate spout being stopped. They then feed them off on the land in the fall. Sheep and young cattle thrive well on this excellent food, and it will be found particularly advantageous when pastures are dry and scanty. This soiling crop gives stock a good start for the winter. Among the ordinary fall turnips the most suitable varieties are the yellow Aberdeen, greystone, and the ordinary white.

When and How
to Harvest
Swedes and
Store for
Winter.

In Northern Ontario the time to harvest swedes is the last days of October; the first week in November answers in Central Ontario. There are various methods of doing this work when help is



66. BREED WEEPER.

plentiful. The old method of pulling and topping by hand, throwing the roots of four drills into one row for convenience in loading into the waggon, is preferable. In many cases, however, other methods have been adapted in order to save hand labor. One of these is to top the turnips with an ordinary hoe and drag them out of the ground with the harrows by harrowing across the drills, letting the harrows half lap if necessary. This method answers well in sandy soil, but in clay soil the turnips are considerably injured in the process, and, as a rule, there is more earth clinging to the roots than is desirable. Another method is to top with the hoe and cut off the roots with an iron plow without the mould-board, and having the wing of share wide and sharp to cut off the tap roots. Still another method, and one generally followed in many sections of the country, is to use a heavy hoe or mattock, both to top and to root. Turnips should be left on the ground for a day or two after being pulled, as they are not so easily injured by frost as other roots. Indeed, it has been found that three or four degrees of frost rather improves their keeping qualities. The same directions for storing mangel-wurzels, both in cellar and pits, hold in the storing of turnips for the winter.

CHAPTER XIII.

EXHIBITION ROOTS.

It may be interesting to many, especially young people, to know how to grow monstrous roots for exhibition purposes. It is like feeding and preparing animals to win prizes—more for glory than for profit. However, it is interesting to demonstrate that one small mangel-wurzel seed planted, say, on the 10th of April, will, by the 10th of October, with proper care, develop into a root weighing over sixty pounds. The first thing to be done in the preparation of soil is to underdrain it; then early in the autumn prepare a clover sod as before described for mangel-wurzels and sugar-beets. In October, subsoil the rotted soil ten or twelve inches deep; then give a heavy coat of well-rotted farm manure. Incorporate this thoroughly with the surface soil (which is simply rotted sod) by cultivating and harrowing several times. Make shallow drills five feet apart, by plowing two or three rounds to each drill. Shape the drills with a garden rake. After this cover all the surface with thoroughly rotted manure. The seed should be sown early in April, on the drills, at intervals of three feet. Sow five or six seeds together. After the plants have grown one or two inches, thin out to three plants, and eventually to the one most vigorous. Follow the above plan for mangel-wurzel and sugar-beets. Carrots and parsnips may be sown two feet apart. In order to get turnips full grown for exhibition they should be sown early in May, and afterwards thinned as indicated for mangels. Sow salt and land plaster (gypsum) over the whole surface. Loosen the surface soil frequently during the whole season, and on no account allow a crust to form on the surface. In growing mammoth roots and vegetables for exhibition, much valuable knowledge may be gained by the grower.

How to Grow
Roots for
Exhibition.



HAYING AT THE ONTARIO AGRICULTURAL FARM.

CHAPTER XIV.

POTATO GROWING.

The most suitable soil for potatoes is a thoroughly rotted clover sod. This is prepared by plowing shallow in the autumn, then rolling, harrowing and cultivating alternately until October. Then cover with well-rotted farmyard manure, and rib as in the preparation for mangel-wurzels. In the spring the cultivation must be thorough. If the soil is a clay it should be subsoiled as deep as possible to let in the air, warm the soil, and assist in the decomposition of vegetable matter. The drills are opened out with a drill plow, with marker thirty inches wide (*see Ill. 13*), or with ribbers attached to the frame of the stiff-tooth subsoiler (*Ill. 48*). The drills should be made about four inches deep. Plant medium-sized potatoes, cut in sets, with from two to three eyes in each. Drop the sets in the drills twelve inches apart; then cover with the drill plow or ribbers, and after ten days harrow down nearly level, and smooth with a Breed weeder (*Ill. 66*). The weeder should be used freely at this stage, and even after the potatoes have made considerable growth. Use the horse hoe frequently during the growing season. The cultivation should be on the level, and on no account must the potatoes be banked up, but the last time this work is done the teeth of the scuffler may be changed so as to throw the earth towards the potatoes, and thus prevent their being sunburnt.

While there are machines for cutting potatoes for seed, and some of them do the work fairly well, the ordinary farmer is content to cut the sets by hand. To do this work properly, cut off the stem

Cultivation and
Drilling for
Potatoes.

How to Cut
Potato Sets
and Time to
Plant.

end of the potato first. This will invariably have one or two eyes. Then revolve the potato in one hand and cut with the other, so as to leave one or two eyes in each set. Split the seed end; by experiment this has been found to give the best all-round results. The time to plant early potatoes depends largely upon circumstances. If wanted for the early market it is necessary to have the land thoroughly prepared the previous fall. Plant soon after the middle of April in Central Ontario. The soil being cold so early in the season, in addition to deep subsoiling lime may be used to advantage in warming it so as to make the plant food available. In all cases it is advisable to plant early varieties early in the spring, so that they will be matured before the hot, dry weather, and in good time for the early market. It is better not to plant late varieties until the end of May, in order that they will keep on growing during the hot weather and be ready to harvest by the tenth of October. To recommend, from the long list of varieties grown at the present time, the best to plant, is a difficult and unsatisfactory task, as those varieties which are so popular at the present time may, in a few years, be far behind some other varieties now unknown. The Early Rose may be considered an exception, for this variety, which held first place for many years, is to-day still a close rival for first place as an early potato. The Early Six Weeks and Early Ohio are among the first of extra early varieties. Among the late varieties the Delaware stands among the first.

There are many kinds of implements used in digging potatoes, ranging from the spading fork to the combined digger and picker. *See Ill. 12.* The common plow, however, is generally used. The

Digging,
Pitting and
Storing
Potatoes.

potato-digging attachment for the drill plow (*see Ill. 13*) works fairly satisfactory. Potatoes will keep much better during the winter if, after digging, they are pitted in the field for ten days, that they may sweat; cover the pit with straw and a light covering of earth. The straw prevents the earth from mixing with the potatoes. Store for the winter, and ventilate according to the directions given for the mangel-wurzels. Potatoes pitted during the winter are usually firmer and of better quality in the spring than those stored in cellars.



EARLIEST SIX WEEKS POTATOES.

CHAPTER XV.

RAPE FOR FODDER.

Cultivation and
Feeding of
Rape.

Dwarf Essex Rape is a succulent fodder plant that should be grown more extensively in this country than it is, as it grows luxuriantly and is of great value for fodder. An ordinary crop will yield over twenty tons per acre of a most nutritious food. By sowing, say, half an acre or more early in May, it will be ready in July for the lambs at weaning time, and also for young growing pigs, and can either be fed on the land or hauled to the stables. The general crop should be sown from the 20th of June to the 1st of July. The same preparation of the soil is required as that necessary for a root crop. Rape grows to the greatest perfection when sown in drills the same as turnips. The drills should be twenty-five inches apart. Two pounds of seed per acre will be found sufficient. The cultivation is similar to that of turnips, excepting that hand-hoeing is not necessary. Rape can be grown successfully as a catch crop after early potatoes or grain are harvested. All animals do well when fed a daily ration of rape during the fall, but it is objected to for milch cows because of the taint given the milk. In order to keep rape for early winter feeding it should be cut about the 20th of November with an ordinary scythe and forked into small heaps, and hauled to the stable as required. When frozen, leave in the stable to thaw out before feeding.

CHAPTER XVI.

CORN FOR SILAGE.

In the preparation of land for corn we must take into consideration that this plant is, to a certain extent, semi-tropical, and is better adapted to a warmer climate than ours. However, by preparing the soil with a view to keeping it warm during the growing season, we may expect good results. In the first place, the land (well-rotted clover sod) must be either naturally or artificially drained, and thoroughly cultivated and manured the preceding fall, and ribbed the same as for roots. If the land was manured in the winter it will be necessary first in the spring to gang plow it shallow, say three or four inches deep, so as to incorporate the manure with the surface soil. Then harrow and cultivate thoroughly before sowing it; if a clay subsoil, loosen not less than ten inches deep. Then harrow and cultivate until the land is in fine tilth.

Preparing the
Land for Corn.

In Central and Northern Ontario, as a rule, the best results are obtained by sowing silage corn the last week in May. There are many varieties to choose from. When making a selection, every farmer will have to be governed according to soil and locality. In Southern Ontario a later and larger variety can be grown than is possible further north. It is useless to grow a variety for silage which will not be in a firm, dough state by the 15th or 20th of September. The flint varieties are invariably earlier than the dent varieties. For Northern Ontario I would name North Dakota and Compton's Early, both of which are flint varieties. The former is white and the latter yellow. From the roots of these

Time and
Varieties of
Corn to Grow
for Silage.

(and most other flint varieties) grow up a number of shoots. For Central Ontario larger and heavier yielding varieties may be grown, viz.: Wisconsin No. 7 White Dent, Leaming, and White Cap Yellow Dent. These, being dent varieties, do not throw up any shoots. Under favorable circumstances they will yield from 15 to 20 tons per acre. One-fifth of the weight will be ears, while the bulk yield of the flint varieties named is rather less in the total than the dent varieties. The proportion of ears is about the same. For cutting and feeding green the sweet varieties are considered preferable.

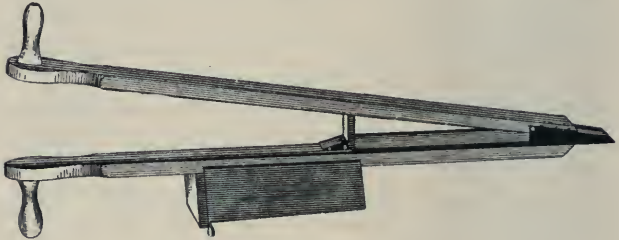

67. HAND CORN PLANTER.

Mammoth Sweet is one of the heaviest yielders and is of fair quality.

There are several methods of sowing or planting corn, each of which has advantages under certain conditions. If the land has not been thoroughly cleaned of weeds and weed seeds the previous fall it is advisable to plant in hills, so that the land can be cultivated both ways. This can be done by the use of a corn marker, marking both ways. Drop four or five kernels in each cross, either by hand or with a hand planter. *See Ill. 67.* The American check row planter is expensive, but does the work most satisfactorily. When planting in hills forty



68. SCUFFLING CORN AT THE ONTARIO EXPERIMENTAL FARM.

inches apart, about fifteen pounds of seed per acre is sufficient. When the land is fairly free from weeds and weed seeds, corn can be sown with an ordinary grain seed-drill (*see Ill. 56*), stopping all the spouts but two, leaving six spaces (forty-two inches) between the rows of corn. A drill with an odd number of spouts, say eleven or thirteen, is preferable, as the teamster will not be so liable to make

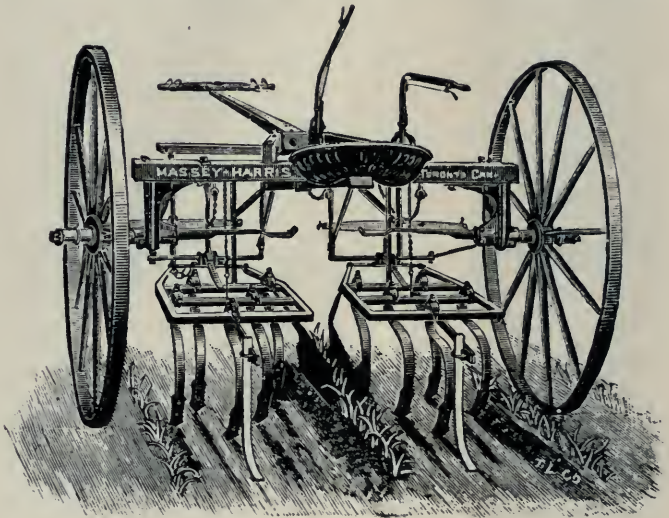

69. CORN CULTIVATOR.

a mistake. A careful driver should make the drills perfectly straight and even and sow twelve acres per day. Twenty pounds of seed corn per acre is sufficient. As soon as sown the land should be crossed with a light harrow or a Breed weeder, then on the angle and again across, until the corn is up. After this use the weeder lengthwise, covering two drills at a time, raising the two teeth in line with

each row of corn (as before described). When the corn is a few inches high, start the two-horse corn cultivator. *See Ill. 69.* Use the narrow point first, so as to loosen the soil several inches deep. This is

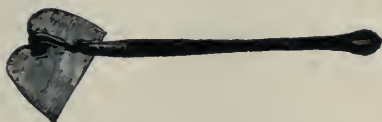

70. CORN HOE.

followed with the Breed weeder to make a fine tilth, kill weeds, and assist the bacteria to act on the humus and make it available for plant food. Corn, being a gross feeder, requires a large amount of soluble food, which can only be prepared by thorough

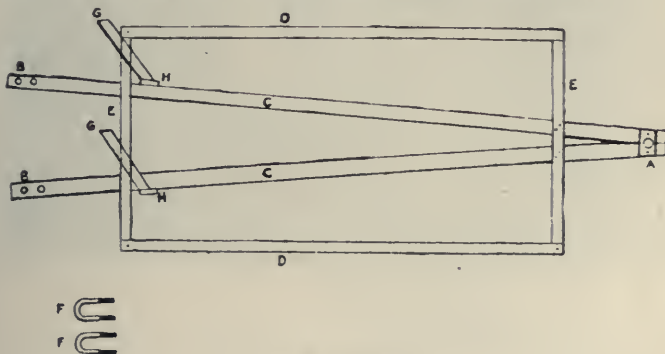

71. CORN PLATFORM.

cultivation. The weeder and the two-horse corn cultivator should be used alternately until the corn is too high to work over. Then it becomes necessary to use a one-horse hoe or scuffler (*see Ill. 63*), which should be continued until the corn is about six feet high. After this a cultivator with harrow teeth is

all that is required to pulverize the surface. *See Ill. 14.* All cultivation may cease after the corn is in tassel.

When and How
to Harvest
Corn.

The time to harvest corn for silage is when it is in the firm, dough state. Until recent years most of the corn was cut either with the reaping hook or corn hoe. *See Ill. 70.* On account of the scar-



72. CORN CUTTING AND SILO.

city of labor these methods have been almost discarded. At the present time the most common implement is the corn harvester. *See Ill. 73.* With this implement a man and team can cut and bind in bundles six acres per day. Whether or not the corn should be taken to the silo immediately after being cut depends on its condition. If rather green and full of juice it is better to lie on the ground after

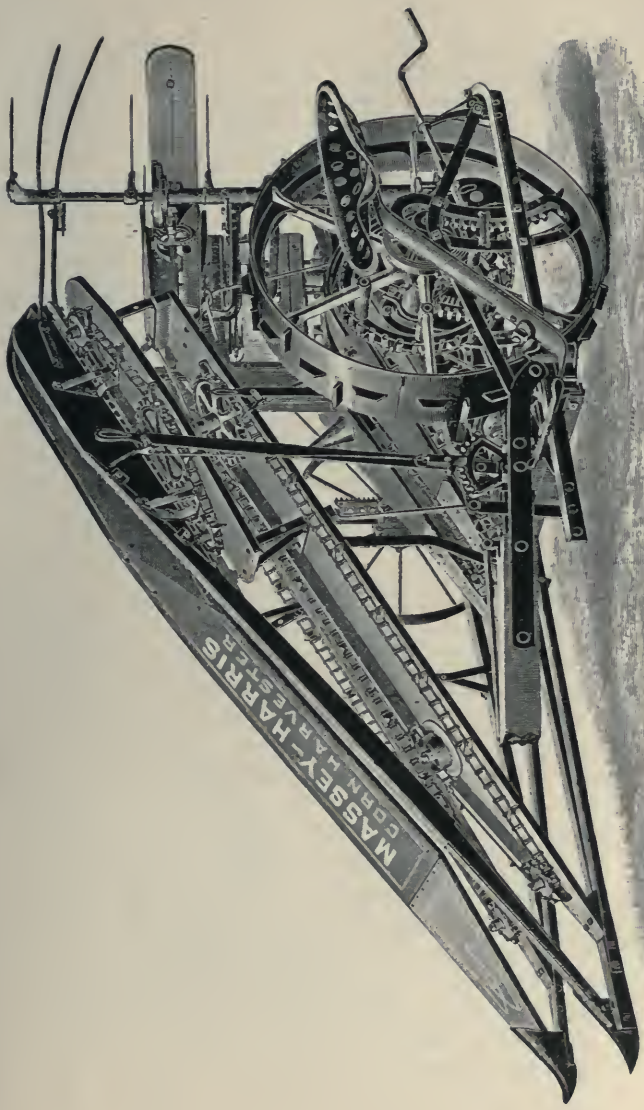

73. CORN HARVESTER.

being cut for half a day or more to wilt; otherwise the silage will be sour. Corn to be put in the bottom of a silo should be nearly matured. If the corn gets frozen, the sooner it is put into the silo the better. If it becomes over-dry, water may be added after the silo is about half filled. A low platform, attached to an ordinary waggon, is what is required for hauling corn to the cutter at silo. *See Ill. 71.* There are several types of silage cutters, any of which will be found satisfactory. The self-feeding table is an advantage, and the blower is an improvement over the carriers, although it requires more power. To elevate from eight to ten tons per hour, thirty feet high, requires an engine of not less than twelve horse power. *See Ill. 72.* The most suitable length to cut corn for silage is a debated question, but it is generally conceded that a half-inch cut is about right.

Corn and Other
Silage Crops.

In addition to corn, which is preferable to all other fodder crops for silage, are the clovers, which make a good quality of silage. Clover is specially adapted to feed with corn and other carbonaceous foods. Alfalfa gives the largest yield of any of the clovers, and being a perennial, it can be cut in succession for a number of years. Alfalfa and orchard grass, or brome grass, make a better balanced ration than any individual plant (including corn), and being perennial, they will stand for years, and give an abundance of succulent food without any expense for cultivation, except a top dressing every winter with good farm manure. The time to cut and put in the silo is when the clover is in bloom. The first cutting of alfalfa and orchard grass or brome grass is usually heavy and difficult to cure for hay, but it can be put into the silo as soon as cut (and partially dry) to prevent clogging

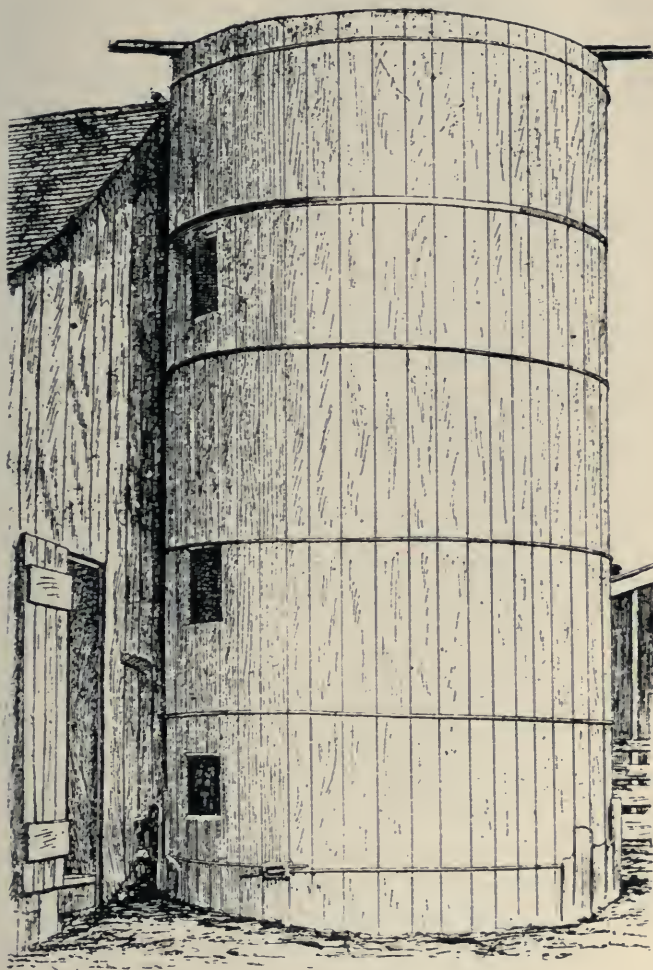

74. ROUND STAVE SILO.

in the blower pipe. The second and third cuttings can be cured for hay or pastured, but not too close.

The silo is no longer an experiment. In those sections of the country where corn cannot be grown successfully, every farmer should build a silo and fill it with some green crop adapted for his section, say peas and oats mixed and cut green. This will make an excellent quality of silage for winter feeding.

In filling a silo with corn or any other fodder crop, care should be taken to keep the surface level and well tramped, particularly around the sides, as this will assist in excluding the air. After fermentation commences the silage will settle rapidly. As soon as the silo is filled—or say, all that is to be put in at that time—scatter salt over the top, then cover with five or six inches of chaff or cut straw, and sow over it barley or oats. Water every day for a few days, and tramp thoroughly over the surface, especially on the sides. The grain will soon grow and make a close air-tight covering which will prevent the silage from spoiling. A cloth saturated with any cheap oil, or paint, makes a good covering, but the cloth will not last more than two or three years.

It requires five or six weeks for silage to cure and be ready for feeding. In the meantime it is well to have sufficient corn shocked, either in the barn or outside, to cut daily as required for feeding.

Construction of
Silos.

There are several styles of silos in use. To decide which is preferable will depend to a certain extent upon circumstances. The round, wood stave silo (*see Ill. 74*) has certain advantages. It is simple in construction, and is the cheapest. The cost will be about seventy-five cents per ton—that is, a silo of one hundred tons capacity, will cost about

seventy-five dollars. Most farmers will have no difficulty in constructing a round stave silo. The staves are cut generally two by six inches, the length varying according to the height of the silo. For a thirty-foot silo, use staves sixteen and fourteen feet long, joined alternately, so that the joints will not be opposite each other. The joints are made by sawing a groove in the ends and fitting in a piece of hoop iron. It is advisable to have a cement floor in the silo. The hoops may be made of heavy band iron (or three-quarter inch round), each hoop in two sections, arranged so that they can be tightened or loosened as required. In making connections, use a block of wood or casting. *See Ill. 74.* Openings eighteen by twenty-four inches each, three feet apart, can be cut after the silo is built, to throw out the silage. Cut in a slant, so that they will fit closely. The first door should be near the bottom. A number of half-inch holes may be bored to allow the surplus moisture to escape. The stave silo has the advantage of being portable, so that a farmer on a rented farm can take it with him at the expiration of his lease.

The stave silo, where permanently located, can be improved very materially by bricking it up inside four inches thick, the same as wells are bricked, and plastering inside with cement. This makes the silo air-tight and frost-proof, which are two very important factors necessary to secure and maintain a good quality of silage.

For a silo that is durable and satisfactory in every respect, the cement silo can be recommended. *See Ill. 72.* As a rule these are built round. Iron rods can be built in the walls to bind the structure together, so that an opening can be left from top to bottom, instead of using doors through which to

get the silage. These openings, eighteen inches wide, are closed when the silo is being filled by setting in inch boards, ten or twelve inches wide, with an overlap to break the joints. Set them against cleats nailed to the frame of opening, two inches back from the inside face of the wall, so that, when set in place, the boards are even with the wall. These boards are set in as the silo is filled, and taken out and tacked about four feet above as the silage is taken out from the top. This is a very convenient way of getting the silage out. There is an advantage in a long silo, so that a partition can be built across in order to make two compartments, one of which is about double the size of the other. The silage of the large compartment can be for winter feeding, and the smaller for summer use. It does not require a mechanic to build a cement silo. It is scarcely necessary to give details in this work, as the manufacturers of cement supply full instructions to their customers how to construct silos and other farm buildings. The cost of building a cement silo is from one dollar and a quarter to one and a half per ton capacity.

When building a cement silo the walls may be filled with field stones, which will lessen the cost very materially, but the stones must be kept two inches from the sides of the silo, otherwise the silage next the stone is liable to be injured and the wall is weakened.

In estimating the capacity of a silo, allow forty pounds per cubic foot for a silo twenty-five feet deep, and forty-five pounds for a silo thirty feet deep.

In taking out silage, commence at the top and keep the surface level. A heavy rake is the most suitable tool for the purpose.

The amount of silage to winter full-grown animals is about four tons each, in addition to other fodder.

Some are under the impression that corn shocked in the field and cut or shredded as required is equal in feeding value to silage, and according to analysis there is little difference, except that there is less water in the dry corn; but in practical experiments in feeding there is a very great difference in favor of silage.



YELLOW DENT CORN.

CHAPTER XVII.

FALL CULTIVATION.

Fall Cultivation After the Hoe Crops.

Having given the cultivation, harvesting and storing of the hoe crops grown on No. 3 section in the rotation for mixed farming, it will now be in order to give the fall cultivation of the land after corn and roots, which is to be followed by spring grain.

If the corn land is free from weeds, all that is required is to rib the land with the drill plow or the ribbing attachment on the frame of a cultivator, as shown in previous illustrations, making the ribs twenty or twenty-one inches wide, so that there will be a row of corn roots in each alternate rib.

If the land is not perfectly free from weeds, the land may be cultivated across with a stiff-tooth cultivator to turn out the corn roots, so that the land may be harrowed and cultivated with the wide points, then ribbed, so as to put all the corn roots and surface soil in the centre of the narrow ribs.

By so doing the soluble fertility is prevented from leaching away during the winter, as the rains and melting snows will run off in the furrows without carrying away any of the humus.

Another advantage is that this allows the frost into the subsoil to loosen it. Land ribbed in the fall will dry out much earlier in the spring, and will make a much better seed-bed.

Root land cannot always be cultivated in fall, on account of the tops. Especially is this true of turnip land. If there should be an occasional thistle or any other weed, it may be cut off with a hoe or spud; but, if at all possible, cultivate all root land with the wide point before ribbing in the fall.

The month of September is a specially good time to cut off all perennial weeds below the surface. By so doing the top is prevented from nourishing the root, and the next growth will be destroyed by the frost. This severe drain on the roots will weaken them, and a heavy crop of grain or clover the following season will be comparatively free from weeds.

All root land should be ribbed (not plowed) in the fall, about twenty inches in width, and across the turnip drills, so as to incorporate the tops evenly with the surface soil. Run furrows (with the double mould-board plow) in the low portions to carry off the surface water. Land which is ribbed will keep much drier than land which is plowed in ridges of, say, fourteen feet wide. Besides the following crop will be much more abundant, as it will be more uniform.

When root or corn land is plowed in the fall the following crop will frequently be lodged in the centre of the ridge, where a double portion of vegetable matter has been gathered, and in the furrows where the vegetable matter has been turned off there will not be half a crop. These are facts which are within the experience of every farmer.

CHAPTER XVIII.

CULTIVATION FOR SPRING CROPS.

See Diagram 54, page 102.

When and How
to Sow Spring
Grain, Clover
and Grass
Seed.

We will now deal with No. 4 section of the farm plan, which is all for grain.

Spring grains follow the hoe crops, corn and roots, which received all the manure made on the farm the year previous. This has been kept on the surface along with the rotted clover sod from the previous fall, and gives us two or three inches of available plant food of the very best kind, suitable to grow an abundant crop of grain and clover.

The fall wheat was sown the previous fall, after peas, and seeded with timothy at the same time the wheat was sown; the red clover and alsike being sown in the spring, with a grass seed sower (*Ill. 52*), at the rate of seven pounds red clover and three pounds alsike per acre.

Seeding and
Care of
Meadow and
Pasture Lands.

As soon as the land is dry, cross-harrow the fall wheat to break up and pulverize the crust that has been formed by the melting snows and spring rains. This will improve the wheat and insure a catch of clover.

Spring wheat and oats should be sown as early as possible in the spring, following corn and roots.

The ribs that were made up in the fall are first harrowed and cultivated down. If the subsoil is clay it should be loosened nine or ten inches deep with the stiff-tooth subsoiler, using three or four horses. Again harrow to a fine tilth. Then sow the wheat or oats with a grain drill at the rate of one and a quarter bushels per acre of good sound grain. The seed should be treated for smut in



75. A FIELD OF MARQUIS WHEAT.

exactly the same way as that described for fall wheat on page 110. Clover and grass seed should be sown at the same time, in the following proportions: Seven pounds red clover, three pounds alsike, and four pounds timothy. Sow these in front of the grain spouts, so that the seeds will be sown on the surface and the grain spouts will throw the seed between the rows of grain, where they will not be liable to be choked out. After the grain is sown, harrow across with a lever harrow (*see Ill. 76*) or Breed's weeder, to smooth the surface. Do not roll until the land is thoroughly dry, even if by that time

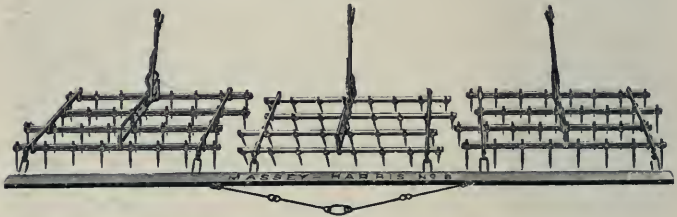

76. LEVER HARROW.

the grain is three or four inches high. The roller will then pulverize the lumps of earth without making a smooth surface, which would encourage evaporation of the moisture in the soil.

For the best results it is not only necessary to cultivate the soil on scientific principles, but it is also equally necessary to sow selected grain from a variety that will give the largest yield, and that of a good quality.

While barley requires to be sown early in the spring for best results, it will not stand so much cold and wet as spring wheat and oats. It is advisable, therefore, to sow the latter first and the barley later.

The land is prepared for barley the same as for wheat and oats, viz., by harrowing and cultivating down the narrow ribs made in the fall. While it is necessary to loosen the subsoil for other crops, it is more so for barley, as this crop will very soon turn yellow in cold, wet soil. Sow with a grain drill at

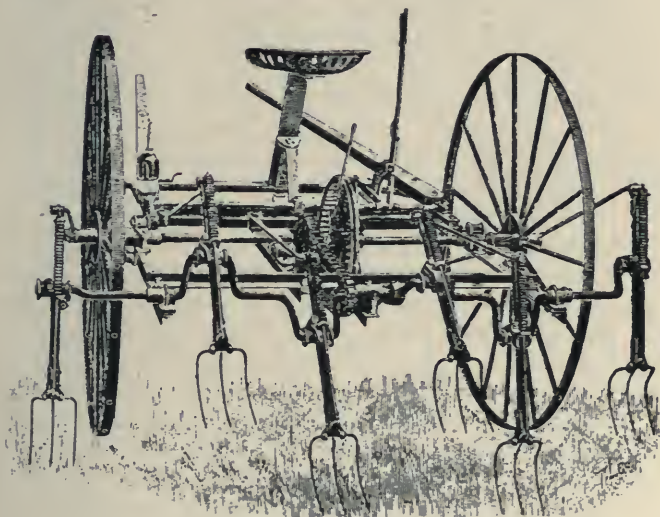

77. HAY TEDDER.

the rate of one and a half bushels per acre of the heaviest yielding variety known.

Barley ground should be also seeded with the same mixture as wheat and oats, so that the whole section (No. 4) will be in grass the following year.

While it improves the quality of barley to cover the shocks with caps at harvest time, it is a question whether or not it pays to do so; but the same caps may be used for the clover, and this is a great advantage in a wet season.

As soon as the grain crops are harvested, and before the stubbles are horse-raked, if there should be any portion of the clover and timothy rather thin through the grain lodging, or from any other cause, it is advisable to scatter seed over these places by hand, or with a grass seeder. By fall these parts will have made sufficient growth to stand the winter, and thus a uniform crop will be assured the following season.

The following year No. 1 section (*see Diagram 54*) will be in hay or pasture, as desired. If the soil is in proper condition it will require no attention further than to keep all live stock off it. In the early spring, until the land is dry and the clover has made a good growth, harrowing meadows and pastures in the spring, with a chain harrow, will improve them. *See Ill. 4.* This pulverizes and smooths the surface, and consequently hastens vegetation.

In deciding on a mixture of grass seed, the first thing to consider is the soil and purpose for which it is required. For hay it is necessary to sow a mixture which will mature at the same time. For pasture, although it is not absolutely necessary, it is preferable to sow varieties that mature at different times during the summer.

In a rotation where the crop will be required both for meadow and pasture, and where the land varies so that some portions are dry while other parts are wet, the mixture recommended previously will give general satisfaction—that is, seven pounds red clover, three pounds alsike, and four pounds timothy per acre.

The first crop will be nearly all red clover where the land is dry. The wet portions will yield only alsike and timothy. The second year the crop will

be nearly all alsike and timothy, as the red clover is a biennial, while the alsike and timothy are perennials. Although it is not always necessary to mix any of the grasses with the clovers, it is always advisable to sow clovers with grasses. The latter are nitrogen feeders, and must have nitrogen in the soil, otherwise they will become sickly. It is well known that timothy sown without red clover will soon die out, whereas, if sown with red clover, it will grow luxuriantly for several years after the clover has died out.

As a fertilizer our common red clover is a most valuable plant. It collects the free nitrogen from the air and deposits it in the roots near the surface of the soil, through the bacteria of nitrification. The tap roots strike deep into the subsoil and bring up soluble mineral matter sufficient to develop the plant, and this is made available to feed other crops. Thus, by growing clover in a short rotation of crops, the fertility of the soil can be maintained. Again, the clover roots perforating the subsoil and decaying there leave the subsoil more porous than it can be made with any implement.

Clover a Fertilizer, Subsoiler and Flesh Former.

According to analysis clover hay, when properly cured, is worth considerably more than any other hay for feeding live stock of all kinds, including horses and pigs. It is the best flesh former and strength giver. It improves and balances the other rations, so that there will be less waste when feeding concentrated food.

The curing of clover is an important matter. It should be cut when coming into full bloom, and shaken out with a hay tedder (*Ill.* 77) soon after being cut. When it is sufficiently dry, rake it into wind-rows and put into ricks. All that was cut in the forenoon might thus be put up in the afternoon,

Curing Clover Hay.

or more, if the weather is hot and dry. The proper place to cure both red clover and alfalfa is in the rick. Hay caps (*see Ill. 78*) are very little used in this country on account of the expense. They cost about forty cents each.

Growing
Clover for
Seed—Harvest-
ing and
Threshing.

The Province of Ontario is especially adapted to the growing of both red clover and alsike for seed, and an immense quantity is exported to Great Britain and Europe annually. The seed from alsike matures in the first growth. It is fertilized by the

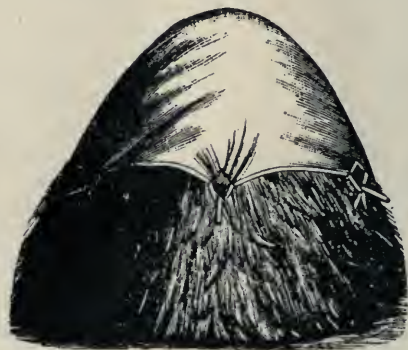

78. HAY CAP.

honey bees distributing the pollen as soon as it comes into bloom, also by the wind scattering the pollen from the stamen to the pistil flowers.

For the best success in raising alsike seed it is advisable that a few colonies of bees be kept in the neighborhood, and then with the wind and bees it may reasonably be expected that the clover bloom will be well fertilized, and without fertilization there can be no seed. It is a most important consideration in growing alsike clover for seed to have it free from weed seeds. "The Seed Control Act" passed by

Parliament in 1905 makes this absolutely necessary. Every farmer who intends to grow alsike and red clover for seed must first clean his farm of weeds. This can be accomplished by proper cultivation. Plow the beginning of August about four inches deep, then roll and harrow twice to form a mulch. In about two weeks cultivate 3 inches deep; then harrow; again roll and harrow to make a fine tilth to encourage all the seeds in the soil to germinate. Every two weeks cultivate with wide points, and harrow alternately until October; then spread eight or ten loads of well-rotted farm manure (free from weed seeds) per acre. Rib the field as described after a hoe crop.

In the spring, level the ribs down with a harrow and cultivator, then drill in either oats or spring wheat, one and a quarter, or barley, one and a half bushels, per acre. Sow in front of the grain spouts ten pounds of pure alsike clover seed per acre, entirely free from weed seeds (even timothy seed).

The same treatment applies to red clover, which should be sown at the rate of twelve pounds per acre, also free from weed seeds. In the care of clover, however, the ordinary mixture of red clover, alsike and timothy may be sown, and the first growth cut for hay, while the second growth of red clover can be kept for seed. The seed from red clover is matured in the second growth, on account of the fertilization being done by the young bumble bees, which are not sufficiently developed for the first growth of red clover, as they are all hatched in the spring. (Only the queen bumble bees live through the winter.)

To get the largest yield and the best quality of red clover seed the first growth should be cut for hay early in June, when the first clover heads appear.



79. MOWING MACHINE.

This is necessary in order to escape the red clover midge, which has proved so disastrous to the raising of red clover seed in most parts of Ontario for several years. The larvæ from the first brood of the midge is deposited in the clover heads immediately they appear and before the bloom shows (when the midge are numerous very little bloom ever appears). When the clover is cut at this time and cured for hay most of the larvæ are destroyed, and, even if any survive, the second growth of clover will be in

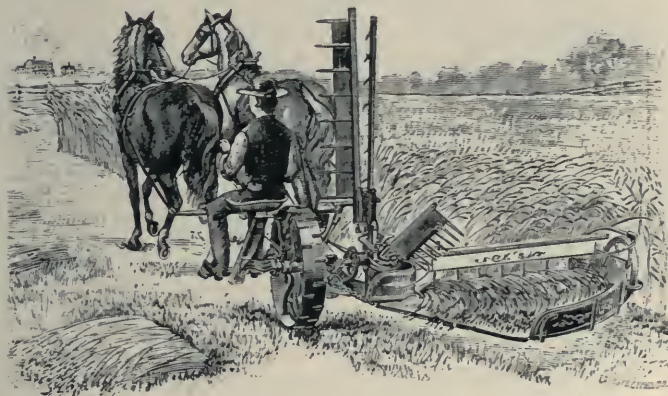

80. SELF-RAKE REAPER.

full bloom before the second brood of midge are developed. Occasionally we get a good crop of red clover seed by cutting the first crop late—say July, so that the second growth of clover will bloom between the second and third broods of midge; but this is uncertain, and has not nearly the same advantage as is gained by destroying the midge by cutting early.

If the first growth has been pastured, the cattle should be taken off by the 10th of June and the land

gone over with a mowing machine (*see Ill. 79*) to cut off any weeds, and also to give the clover an equal start.

It is worthy of note that a heavy growth of clover will check the growth of weeds and materially assist in cleaning the land.

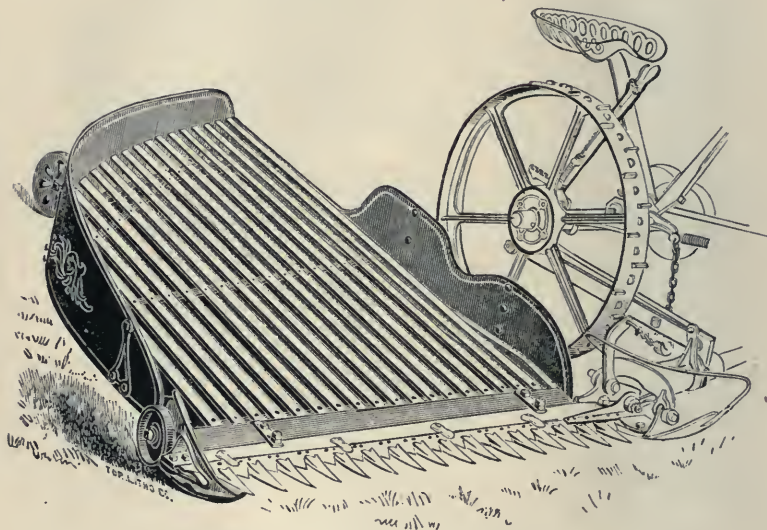

81. MOWER WITH CLOVER SEED ATTACHMENT.

Cutting clover for seed, both red and alsike, is usually done with the ordinary mowing machine and two men following to bunch, with the back of three-pronged forks, putting the bunch aside to clear the horses and machine. A second method is the old self-rake reaper. *See Ill. 80*. With this machine the clover is bunched and put aside without any help.

A third method of cutting clover for seed is to

use the mowing machine, with a platform fastened behind on which the clover drops. *See Ill. 81.* A man puts it off in bunches, using a fork or rake.

A fourth method is in using the pea-harvester attached to an ordinary mowing machine. *See Ill. 57.*

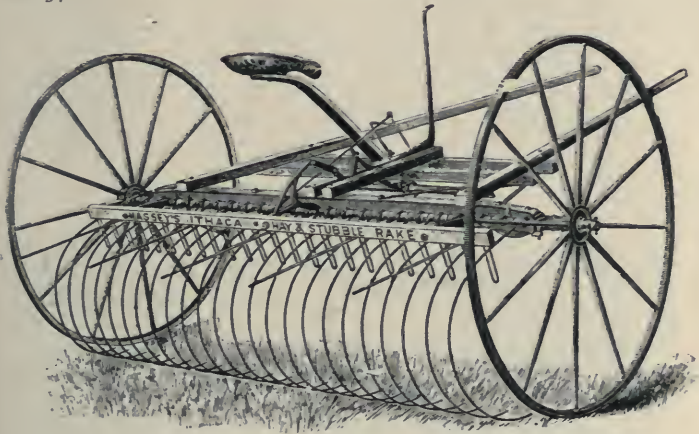

82. HORSE RAKE.

The bunches in either method require to be turned over occasionally so that the clover may dry quickly and thoroughly. This work should be done carefully, otherwise the best seed will be lost. The crop should remain out a week or ten days after being cut, or until it is sufficiently dry to be put into the barn or threshed. The best quality of clover seed, both alsike and red, is got by threshing it as taken from the field.

The curing of timothy hay is, as a rule, an easier matter than curing clover. The very best quality of hay is made by putting up in ricks and allowing it to stand a few days, but this is not always necessary.

Curing of
Timothy Hay.

If the weather is dry and warm, shake out with the tedder (*see Ill. 77*) soon after it is cut, and rake it into wind-rows with a horse rake (*Ill. 82*). If the weather is favorable timothy hay may be sufficiently dry the day it is cut to be taken into the barn. It is loaded on the waggon either with forks or with a hay loader. *See Ill. 83*. In conjunction with the hay loader is the side delivery rake.

These are two great labor-saving implements for handling hay. The rake turns the hay and leaves it loose to dry out and in the best shape for the loader to handle it.



A HEAVY CROP OF GOLDEN VINE PEAS.

CHAPTER XIX.

ALFALFA CLOVER.

Alfalfa is one of the most profitable crops that a farmer can grow. It is destined to revolutionize farming in this country, being the great flesh-forming and milk-producing plant. It is indispensable for arriving at the best results in feeding animals, especially dairy cows and hogs. It gives the earliest

Alfalfa—Its
Desirable
Quality.

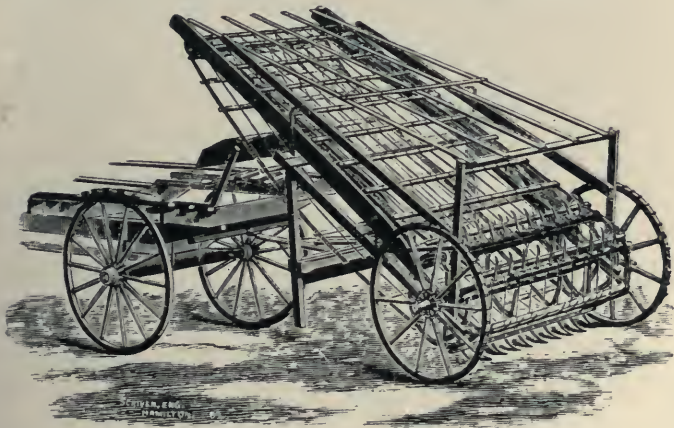

83. HAY LOADER.

and best quality of feed in the spring. It will keep green and continue to grow during the driest weather until autumn, supplying an abundance of the most nutritious and succulent food during the whole summer. As a fertilizer it is the most valuable crop known to science. Being a leguminous plant, it is a collector of nitrogen, and on account of its luxuriant growth all summer it collects a very large

amount of this. Furthermore, the roots penetrate the soil several feet and act on the subsoil, bringing mineral matter to the surface that would never be reached by any other plant. When alfalfa is plowed up and the roots decay the whole subsoil is perforated, so that the air and water have free access to the same. Because of all this alfalfa is the greatest of soil renovators. It has the advantage of being a perennial, so that if the conditions are favorable it will produce three crops each season for many years, and of the most nutritious kind, for all animals. According to analysis this food is nearly equal to bran in nutritive value. For convenience in feeding green during the summer to horses, cattle, pigs, etc., it is advisable to select a few acres near the stables. *See page 102.*

The writer has had considerable experience in growing and feeding this highly profitable fodder crop, and the following explanation of his cultivation, if carefully followed, will lead to the successful growing of this clover in any part of Canada where red clover can be grown. If the land has not been prepared the previous fall according to directions for early crops, it may be prepared in the spring in time to sow alfalfa seed. Plow shallow, roll and harrow; in ten days cultivate and harrow. If the soil is clay, loosen ten inches deep with a subsoil plow or the stiff-tooth subsoiler. Again harrow; then spread on the surface fifteen or twenty loads of well rotted farmyard manure per acre; after which cultivate and harrow until the manure is thoroughly incorporated with the soil. Then sow fifteen pounds of alfalfa seed to the acre with a grass seed sower (*Ill. 52*). Sow at the beginning of June (without any grain), also sow by hand five pounds of orchard grass seed per acre. Then give one stroke with the harrow or Breed's weeder.

The orchard grass and alfalfa are both rapid growers, and when mixed make a better balanced ration, especially for horses and cattle.



(Treated)

(Untreated)

84. ALFALFA CLOVER.

INCREASED RETURNS BY USE OF NITRO-CULTURE.

The first crop will be ready to cut in about two months. Do not cut or pasture late in the fall.

After the first season it can be cut three times for hay and four or five times for green feed. As both alfalfa and orchard grass are perennials, there will be no cultivation required for years except a

coat of farm manure each winter when the land is frozen, to make up for the vegetable matter that has been taken off with the crop.

**Inoculation of
Alfalfa Seed.**

In some parts of Canada alfalfa has not been a success, owing, it is believed, to the want of the proper bacteria in the soil; but nitro-culture, with full directions how to apply it, is now being sent out by the agricultural colleges to all farmers who make application for it.

After a farmer once gets a start he has simply to take surface soil from an inoculated field (about two hundred pounds per acre) and sow it over a field prepared for seeding. In this way the whole farm may be inoculated in due time.

The writer has, however, tried alfalfa in several districts in Ontario, with abundant success, without any nitro-culture, simply by preparing the soil in the way previously explained, and sowing only when the soil is warm. The best months are May, June and July. The necessary bacteria cannot work in cold soil. *See Ill. 84.*

**Alfalfa Adapted
to Hillsides.**

Alfalfa is specially adapted to hillsides that are liable to wash and difficult to cultivate. Such land should be seeded with fifteen pounds alfalfa and five pounds orchard grass per acre. This makes a good mixture to cut for hay or for pasture. For best results the first growth only should be cut for hay. After this the field will provide abundance of good pasture during the summer season, and this is preferable to cutting two or three crops in one season.

**Fertilization of
Alfalfa.**

Alfalfa is fertilized by the honey bees the same as alsike. Either the first or second growth of alfalfa can be allowed to ripen for seed, but the second growth is preferable.

Alfalfa Meal.

Throughout Canada alfalfa meal has come to be recognized as an important food for bringing

cattle up to fine condition, especially show animals. It is also being used with good results for the same purpose in swine and poultry. This meal is made from alfalfa and sugar-beet molasses, in the proportion of seventy-five per cent. alfalfa and twenty-five per cent. molasses. There are a number of factories engaged in the manufacture of alfalfa meal. The hay must be kiln-dried before it can be ground. There is certainly nothing added to the alfalfa by kiln-drying and grinding, nor to the sugar-beets by being manufactured into molasses, except that the food is more concentrated. Equal results may be obtained by cutting the alfalfa hay and mixing with pulped sugar-beets, and at a fraction of the cost.



PORTION OF ROOT OF ALFALFA PLANT.

Showing the tubercles or nodules formed by the nitrogen-gathering legume bacteria.

CHAPTER XX.

PASTURE AND SOILING CROPS.

Permanent Pasture.

In laying out a farm it is advisable to have a field near the barn for pasture and soiling crops. Eight acres, perhaps, are sufficient for permanent pasture. Adjoining this, about six acres might be seeded to alfalfa and orchard grass for cutting and feeding green (soiling). High, dry land is preferable. Before seeding for permanent pasture the land should be thoroughly cultivated, and, if necessary, underdrained; then manured and ribbed in the fall, so that it will be in good shape for spring cultivation, which should consist in harrowing and cultivating the ribs down level. Then, with a grain drill, sow barley at the rate of half a bushel per acre. At the same time sow ahead of the grain spouts the following mixture of grass seed: Alsike, three pounds; white clover, one pound; timothy, three pounds; blue grass, three pounds; red top, three pounds; total, twenty pounds per acre. After seeding, level off with a light harrow or Breed's weeder.

When the barley is about a foot high cut it with a mowing machine (not too close), and leave it on the ground for a mulching.

About two acres of the pasture land should be planted with maple trees (*see Diagram 54*), both for the purpose of ornament and shelter for the cattle. It is advisable not to seed this portion the first year, as the trees will make more rapid growth by keeping the land cultivated for another year. Mulch with farm manure. The silver leaf maple is hardy, and will make more rapid growth than the hard sugar maple. The former is desirable in this case, as it is

wanted for shelter as soon as possible. It is advisable to plant the trees about twenty-five feet apart, so that the whole surface of the soil will be shaded and kept cool in the summer.

In addition to alfalfa and red clover for soiling, other crops may be grown for summer feeding while green, as a succulent food. It is essential to have a sufficient supply of green food in order to get the best results from all animals, including pigs, lambs, calves, and especially milch cows. Peas and oats and vetches and oats make an excellent mixture. Fifty pounds of peas or vetches and thirty pounds of oats (eighty pounds in all) should be sown to the acre.

Additional
Soiling Crops.

Sow one or two acres early in spring and a second sowing three or four weeks later. If this is more than is required for feeding green it can be cured for winter feeding.

Near the end of May one or two acres of sweet corn can be sown, and kept thoroughly cultivated for the same purposes. This should yield fifteen tons per acre of a succulent food of the best quality.

Dwarf Essex rape is also a desirable soiling crop. One or two acres of this may be sown beginning of June in drills twenty-six inches wide, and thoroughly cultivated. All animals are very fond of rape, and when mixed with other foods it gives the best results. All soiling crops should be grown convenient to the stables. For sheep, calves and pigs it is advisable to have a separate permanent pasture near the barn. *See Diagram 54.* For shelter, pigs require, in addition to a group of maple trees, a building to go into at will.

CHAPTER XXI.

THREE YEAR ROTATION.

Three Years'
Rotation of
Crops.

Having fully explained a four years' rotation of crops, according to the *Diagram 54*, which, with certain variations, may be adopted on many farms in this country with success, it will now be in order to explain briefly the advantages and disadvantages of a three years' rotation. For this purpose divide the farm proper (that which is under cultivation) into three sections. Omit the second section of the four years' rotation (*Diagram, page 102*).

Cultivate as follows: One section in red clover, for hay and pasture. This is plowed in August, rolled, harrowed and cultivated at intervals until October, according to various directions, then manured and ribbed. This is followed with a hoe crop and peas, then with a grain crop, again seeding with clover.

This system is desirable when only a limited number of cattle are kept in the summer, the object being to feed cattle and lambs during the winter for export or home consumption.

The advantages of this system are, first, the increasing and maintaining of soil fertility by plowing under the second growth of clover every third year, and feeding all the roots, corn, fodder and coarse grains. Secondly, the labor on the farm is more evenly distributed throughout the year by this system.

With a disconnected or outlying portion of land it may not be convenient to manure and cultivate in the regular rotation.

A three years' rotation may be followed by leaving out the hoe crops and farm manure and

having two sections grass, hay or pasture, and the third section grain, seeding with the regular mixture mentioned in the four years' rotation.

The section that has been in grass for two years is plowed in August and thoroughly harrowed and cultivated alternately until October; then ribbed and sown with grain the following spring, and again seeded.

With this system soil fertility can be maintained without applying manure.

In any rotation land should not remain in grass longer than two years, on account of wire worms and other insects multiplying and so injuring the following crops.

Land intended for pasture only should be renovated every few years by plowing in August, and in order to destroy the wire worms which are almost certain to be in the soil.

Harrow and cultivate alternately and continuously until the winter, say November. The object is, first to rot the sod, and second, to rid the ground of wire worms by disturbing them late in the fall or beginning of winter, so that they may be frozen and destroyed. Seed again in the spring with the pasture mixture of clover and grass seed mentioned on page 168, seeding with any kind of spring grain (barley preferred) sown according to previous directions.

CHAPTER XXII.

FENCING.

Fencing.

Careful attention should be paid to the fencing of the farm. The outside or boundary fence requires to be a substantial structure so that it will turn any animal; at the same time it should not be unnecessarily expensive.

Few Cross Fences.

Sectional or cross fences should be dispensed with as far as possible, as the work of erecting and maintaining these is expensive, and they are, moreover, harbors for weeds. Even on a stock farm it is not necessary to have more sectional fences than are shown on the diagram of a farm laid out for a four years' rotation of crops (*Ill. 54, page 102*), which is the longest course advisable in order to maintain the fertility of the soil.

Cross Fences under Certain Conditions.

In a three years' rotation, fewer sectional fences are required, and where few animals are kept during the summer all the inside or cross fences may be dispensed with except those around the orchard, lawn or private grounds, and that enclosing a small field of permanent grass near the barn, to be used for pasturage and cutting for green feed.

Portable Woven Wire Fences.

There are many styles of portable woven wire fences offered for sale, several of which are cheap and efficient. A good portable fence which is being introduced into many sections of the country with entire satisfaction is constructed by using one of the many styles of woven wire fencing that are being manufactured and sent out in rolls, each being from twenty to forty rods in length.

Convenient Portable Fence.

The posts used should be about four inches in diameter and seven feet long, with one end sharpened to a point. Hardwood is preferable for this purpose.

The posts and wire may be drawn to the field on a waggon. Holes should be made in the ground about eighteen or twenty inches deep (with a round iron bar sharpened at one end) in line with the stakes that have previously been set for the fence. Then take a post, and, inserting the sharpened point, drive it down about two feet with a maul or sledge while standing on the waggon; then drive to the position for the next post, about thirty feet off, and repeat the operation. A few minutes is all the time required to set each post if the ground is in a moist condition.

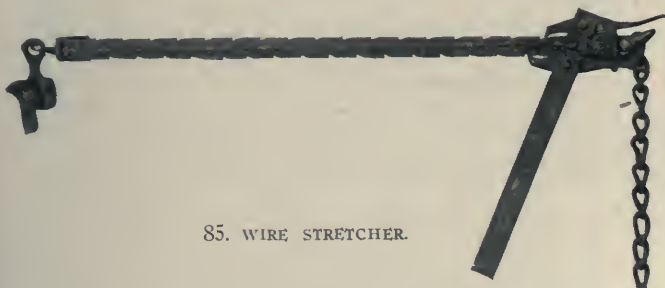

85. WIRE STRETCHER.

When the posts have all been set, unroll the woven wire, fasten it securely with staples to the end post, and tighten with the stretcher shown in *Ill. 85*, fastening the wire to each post with staples.

Fasten Woven
Wire to Posts.

The woven wire costs from forty to sixty cents per rod, according to the style used. The posts cost about fifteen cents each, or an additional eight cents per rod.

Cost of
Portable Fence.

A fence so constructed is easily removed. Simply draw out the staples and roll the wire on a barrel to prevent it from being broken in handling; take up the posts and put all under cover. This causes the posts to dry hard and become much more durable.

Removing
Portable Fence.

Permanent
Woven Wire
Fences.

In the construction of permanent fences the durability of the posts is a very essential matter. They should be of cedar, about six inches in diameter, and long enough to be set about three or four feet in the ground and extend about two inches above the top wire of the fence. The portion which will be underground should be dipped in lime-wash to prevent rotting.

Prevent Posts
Decaying.

Posts should either be rounded on the top or cut on a slant so that the rain will run off. They

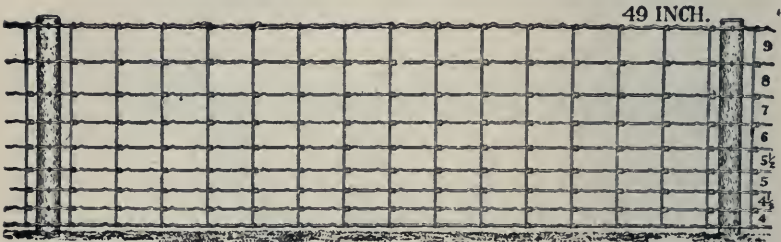

86. HORSE AND CATTLE FENCE.

should also be painted on the top with some mineral paint or cement wash.

Style and
Quality of
Fence.

The next consideration is the style of fence. Woven wire is used more generally than any other. Provided the wire is of good quality a fence made of No. 9 wire, coiled spring steel, galvanized, will be satisfactory. A fence made of this wire will expand and contract with heat and cold without getting out of shape, and will last for many years.

Suitable Styles
for Different
Animals.

A suitable style of fence for horses and cattle is shown in *Ill. 86*, and for a hog, cattle and horse fence see *Ill. 87*. To prevent hogs from raising the fence between the posts, fasten a wire to a piece of wood about four inches in diameter and a foot long. Bury this about twenty inches deep underneath the fence

and fasten the wire that is attached to the centre of block to the bottom wire of the fence. Place these at such distances as are found to be necessary.

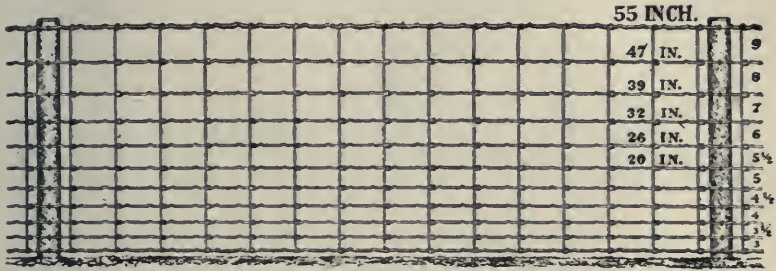

87. HOG, CATTLE AND HORSE FENCE.

For bracing or stretching wire in the construction of woven wire fences, see *Ill.* 88.

On hilly land there is a difficulty in constructing a satisfactory fence of woven wire. This can be

How to Fence Hilly Land.

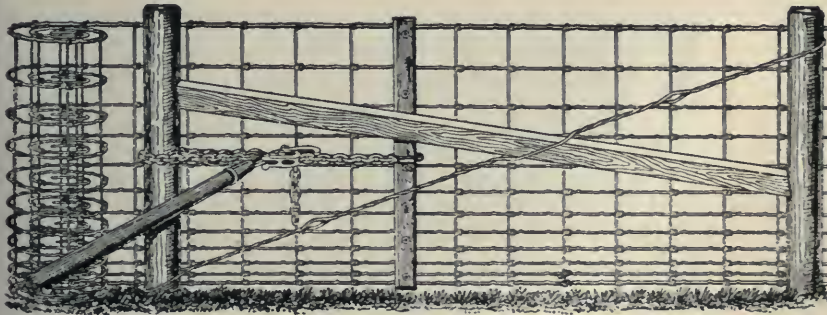

88. BRACING AND STRETCHING FENCE.

overcome to a certain extent by setting the posts closer. A more satisfactory fence still can be made by stretching the strands of wire independently and putting the upright stays on either by hand or with

a machine made specially for the purpose shown in *Ill. 89.*

Farm and
Garden Gates.

All sizes and styles of gates are now supplied by the manufacturers of woven wire fences at reason-

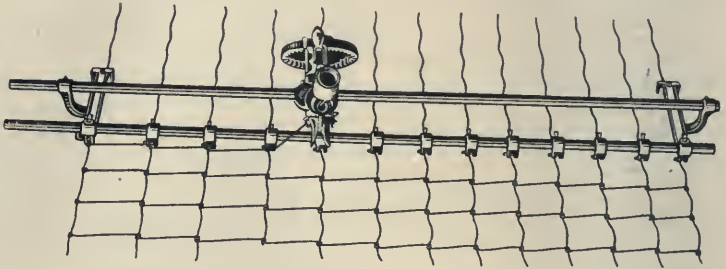

89. LONDON FENCE MACHINE.

able prices. The frames are of wrought iron and filled in with woven wire. They are both durable and ornamental. *Ill. 90.*

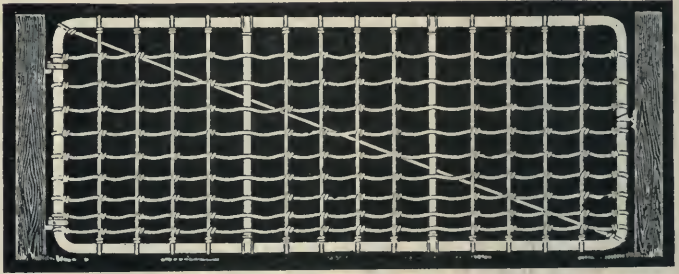

90. WOVEN WIRE GATE.

CHAPTER XXIII.

CARE AND FEEDING OF LIVE STOCK.

It is estimated that eighty per cent. of the grain grown in Ontario is fed on the farm. The grain is the raw material; the stock, butter, cheese, poultry and eggs the finished product. It is important to produce the largest possible quantity of grain per acre; it is equally important to see that the best possible use is made of this grain in feeding it.

The economic feeding of live stock is at the present time receiving special attention at our experiment stations, and during the past few years much knowledge has been gained in the preparing and balancing of foods for different animals, so that rations may be composed of the proper constituents and quantities most suitable for the desired objects to be gained and at the minimum cost. With our present knowledge we receive better results and at much less cost than in former years.

Economic Feeding.

The first object lesson we get from the "laws of nature" is "June conditions." When the weather is warm and the grass in a succulent condition the best results are obtained from our animals, more especially in milch cows.

June Conditions.

Provision should therefore be made for a continuous supply of succulent food during the whole year, both by carrying over a quantity of silage and by growing soiling crops. Where alfalfa can be grown successfully there will be no need of sowing any other soiling crop for summer feeding. Where alfalfa cannot be grown, a mixture of peas and oats,

sown at intervals, will give an abundance of succulent food during the summer season.

**Autumn
Feeding.**

In autumn, when the pastures are again green, and with a supply of corn, the cows should, provided they are kept comfortable, continue to give a full supply of milk, even if fed little or no grain.



91. DEHORNING CATTLE.

**Warm and
Comfortable.**

No farmer can afford to have his animals exposed to cold weather in the fall of the year. When the weather becomes cold all animals should be comfortably housed, and not let out of doors except when the weather is warm, not even for exercise. According to experiments, cattle do better when

kept in a warm and properly ventilated stable all winter without being turned out of doors.

That the cattle may receive daily exercise inside it is necessary to have them dehorned so that they cannot injure each other. *See Ill. 91.* Dehorning

Dehorning
Cattle.



92. A YOUNG HOLSTEIN BULL.

has now become quite common throughout the country. It makes the animals more docile and less fretful; consequently they do very much better. With the proper appliances, and an operator with some nerve, the work is simple and expeditious.

The horn should be cut off close to the head, otherwise a nubbin of a horn will grow again.

**Exercising
Animals.**

With stables and stanchions arranged (as in plan 33), the animals can be turned loose with little trouble. It is advisable to divide the cattle, when loose, in groups of eight or ten each, with temporary partitions between.

**Water in
Stables.**

If there is no provision for a water supply a tank should be kept filled in the stable, so that the cold chill may be taken off the water by the heat from the animals. By elevating the tank the water can be carried to any part of the stable with an iron pipe or a hose.

Winter Feed.

The preparation of the food for cattle in winter will have to be varied according to the supply on hand. The first essential is clover hay, either alfalfa or red clover. Clover is a flesh former, and gives strength to the animals. It improves and balances the ration when mixed with other and more concentrated foods.

For economic feeding, corn silage is one of the most profitable crops that a farmer can grow. According to analysis, valuing alfalfa and red clover hay at six dollars per ton, corn silage is worth two dollars and fifty cents. Practical results depend very much on the preparation of foods.

**Nutritive Value
of Fodder
Crops.**

While dry fodder corn, according to analysis, compares favorably with silage, yet in practical tests there is considerable difference in favor of the silage. While field roots are composed of from eighty-five to ninety per cent. water, yet they are important in the preparation of a succulent winter food. With a supply of clover hay, straw and chaff, silage and roots, prepared according to the following directions, satisfactory results may be gained.

First, spread on the floor of the feed room a layer



93. GUERNSEY COW—"MURNE COWAN."

World's record, 24,008 lbs. milk one year.

of cut clover and cut straw or chaff three or four inches deep. Over this sprinkle a little salt, estimating that each animal receive three quarters of an ounce per day. Make the second layer of silage about two inches deep; the third another layer of cut clover and chaff, with another sprinkling of salt; the fourth layer, pulped turnips, mangels, or sugar-beets, about two inches deep; the above order to be kept until the heap is about four feet high. The pile should be tramped and kept perpendicular at the edges. The size of the heap will of course vary according to the number of animals to be fed.

Allow Several
Hours to
Moisten.

It is advisable to prepare sufficient for a day, and several hours ahead, so that the whole mass will become quite moist by the liquid from the roots soaking through the cut feed, and the fermentation from the silage warming up the whole mass, making it succulent like grass.

Quantities of
Mixture.

In preparing the mixture the following proportions may be taken as a guide: Silage, twenty-five pounds; roots, twenty pounds; cut clover and chaff, fifteen pounds; total, sixty pounds. This should be varied according to the capacity of the animals.

Alternative for
Deficiency.

As a substitute for clover hay, pea straw may be used with satisfactory results, as this is also one of the legumes. In case of a shortage of pulped roots the cut feed may be moistened with water, and in case of a shortage of silage, additional grain should be fed. When feeding the above mixture commence at one end, so that the quality will be equal for each animal.

Feeding Meal
in Mixture.

To get the best results from feeding grain it should be ground and mixed with bran, and in case of all the cattle getting grain it is advisable to put the required amount on each layer of cut clover

and chaff. Different animals require varying quantities of grain according to circumstances. In the case of milch cows, for example, those that give forty pounds of milk per day require more grain than those giving half that amount.

This has much to do with the results. Cattle should be fed early in the morning during the winter season, say between five and six o'clock. The cows should be milked, stables cleaned out and cattle bedded and watered before breakfast. They should be fed no more than they will eat in an hour and a

How and When
to Feed.



94. THE BLACK AND WHITE CATTLE.

half. If any food be left over it should be cleaned away. When animals are not disturbed after being fed in the morning they will rest contented until noon. No animal should be fed between meals. For best results and health of animals this is important.

For cows giving milk the following ration will give satisfactory results, and at a moderate cost: In the morning feed the above mixture, prepared as directed. If no ground meal and bran have been put in the mixture, scatter over the ration when in the manger ground grain and bran mixed, two pounds of the former and one of the latter. At

Ration for
Milch Cows.

noon, clover hay and mangels (whole), without grain. The evening ration the same as that of the morning. The feeder must, of course, use judgment in varying the amount of feed to suit the individual requirements of each animal.

Feeding Store Cattle.

Young cattle and cows not in milk require only the prepared mixture in the morning, clover hay at noon, and the mixture in the evening. Total cost, about seven cents per day, according to circumstances. This is sufficient to keep them in good growing and healthy condition.

Exercise In-doors.

It is understood that the animals are to be comfortably housed, and not turned out-of-doors in cold weather, otherwise it will require more grain to keep up the animal heat.

Commercial Foods.

Good results can be obtained without commercial foods. A limited quantity of oil-cake and cottonseed meal may be fed to milch cows and beefing cattle to advantage, provided the cost is in proportion to the nutritive value of other foods on the farm.

Flesh Forming Foods.

For the health and development of young cattle they should be given foods that will produce flesh, bone and muscle, viz., clover, bran, roots, rape, etc. Fattening foods tend to disease and stunted development.

Kind Treatment.

While every provision may be made for the comfort of the animals, and the feeding done strictly in accordance with the above directions, the animals will not give adequate returns for the food consumed unless they receive kind treatment. This is particularly noticeable with milch cows, say in the month of June.

Results of Abuse.

When on pasture and giving a large quantity of milk, if brought from the field hurriedly by a dog, or a person on horseback, and milked while excited,

the average results will be about half the usual quantity. Some of the more nervous cows will not give one-fourth the usual quantity of milk, and, according to analysis, there is less butter fat in the milk. Any farmer who will abuse his animals, or allow them to be abused, had better go out of the business. He cannot expect to get returns for the food consumed.

Cattle must be kept free from vermin during the winter. They should be treated with about three applications of seal oil (fish oil) and crude carbolic acid, mixed, one gallon of the former and five tablespoonfuls of the carbolic acid. Apply by either spraying or with an ordinary cattle brush, rubbing the cattle over the body. For about three months during the summer, when the horn fly is annoying the cattle, apply the above mixture once a week and the fly will not trouble them. Cattle which have been treated for the horn fly in summer with this preparation are not affected with warbles in winter.

Preparation of
Fly-oil.

In considering the comfort of the animals, a consideration which is essential to success is protection from the hot summer sun. They may be kept in the house during the heat of the day. This, of course, is attended with some additional labor. Such labor can be avoided by having several groups of maple and other trees, a quarter of an acre or more in extent, on rising portions of the farm. Trees planted about twenty feet apart give excellent shelter to the cattle, besides being ornamental. The advantage of having the trees grouped is that the sun cannot shine in to heat the ground, and when on rising ground there is usually a current of fresh air.

Shelter in
Summer.

Single trees scattered over a farm give little shelter, and standing in growing crops they are a decided injury to the crop.

Scattered
Trees
Objectionable.

CHAPTER XXIV.

BREEDS OF CATTLE.

In addition to the feeding and care of animals there is the question of the breed that will give the best returns. This is a debatable question, particularly as regards milch cows.



95. TWO WHITE-FACED BEAUTIES.

Holstein.

The large black and white "Holstein" (*see Ills. 92, 94*) is no doubt the largest producer of milk, although as a rule this milk is not so rich in butter fat as that of some of the other breeds. Yet there are individual animals of the Holstein breed that give rich milk and that have made remarkable records.

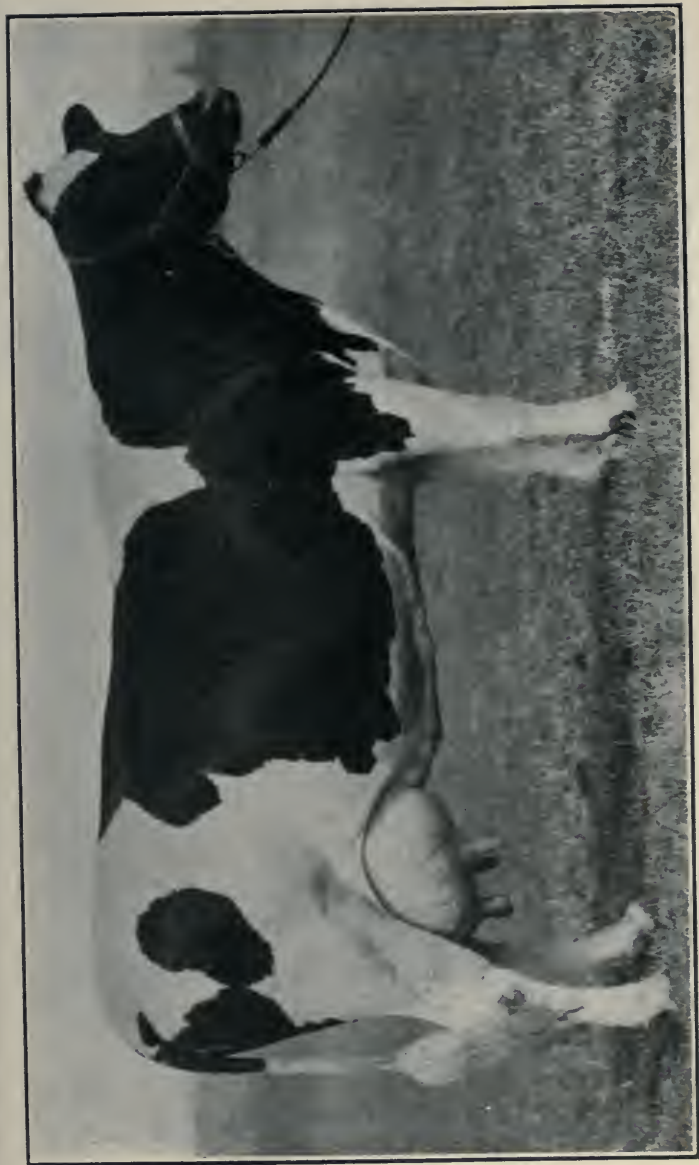

96. HOLLSTEIN-FRIESIAN COW—"FINDERNE PRIDE."

Produced 1,176 lbs. Butter-fat in 365 days.



97. AYRSHIRE COW.

These animals have excellent digestive organs, and can make the best use of food. A delicate feeding cow is not a profitable animal.

While the quantity of milk can be increased by judicious feeding, the butter fat will remain in about the same proportion, but the flavor and color of the milk is changed materially by certain foods. Pumpkins fed in fall will give a rich tint to the butter.

Increasing
Production.

When cows are exposed to cold weather the butter will be white in color, even though the food is of the best. Milch cows should be kept housed in the winter in a stable with the temperature at about sixty degrees, milked at regular hours, and by the same person.

Effect of Cold.

In the selection of a milch cow, consider the following points: First, the "wedge shape" of the animal; a head fine and long; neck thin; large square udder, not fleshy; barrel deep and round. There are other signs, but all of them fail in some animals, since the ancestors have much to do in stamping the off spring. There are other things to consider in developing a milker. One is to have the heifer come in at two years of age and milk for at least one year.

Selecting a
Milch Cow.

The most popular dairy cow in Scotland is the "Ayrshire." See *Ill.* 97. The Ayrshire has the typical wedge-shape of the dairy animal. The horns have an upward curve, the shoulders are thin, and the loins broad. The prevailing color is a reddish brown and white. The udder is large, and the cows are particularly hardy. After milking for a number of years, Ayrshires can be fattened better than any of the other dairy breeds.

Popular Dairy
Cows.

For a fancy cow, and for making "gilt edge" butter, the Jersey or Guernsey (see *Ill.* 98) stand at the head. While the Jersey does not give as large

Fancy Butter
Cows.

a quantity of milk as the Holstein or Ayrshire, the milk is as a rule richer in butter fat and superior in quality. The butter is also more marley, and does not get oily in warm weather like that from other breeds. Both the butter and cream command high prices.

Jersey Cow.

As to shape, the Jersey has all the characteristics of a dairy cow—the deep, well ribbed body, and udder and escutcheon large, with large milk veins running well forward. The favorite color is a solid fawn.

The Guernsey is a larger animal, with the butter quality of the Jersey.

Beef Breeds
not for Milk.

For dairy purposes the beef breeds are not satisfactory. Some of them give a large quantity of milk for a few months, but then as a rule they commence to put the results of the feed on their back instead of in the pail. The same is the case with many of the cows that are cross bred between the dairy and beef breeds. In using such cows for dairy purposes it is advisable to milk them until they cease to give a paying quantity of milk and are ready for the butcher, then sell and replace them with fresh milk cows.

Decide on
Breed Best
Adapted to
Circumstances.

In deciding on what breed to keep, one should be governed according to his fancy, and the market for which the produce is intended, whether a cheese factory, creamery, or a home dairy. If either, or both of the former, the Holstein and Ayrshire will give the largest returns. For a home dairy, with an opportunity to work up a fancy city trade in cream and butter, the Jersey or Guernsey will fill the bill. There is an advantage in keeping pure-bred animals over grades, as the calves are worth much more.

After the first week calves that are intended for

the dairy should be fed skim milk, with a teacupful of ground flax-seed and middlings. These should be mixed before grinding. This prevents the mill from clogging. To keep the calves growing, feed liberally with bulky, succulent food, composed largely of clover, roots and silage. The heifers should have their first calf when two years of age.



SORGHUM—A VALUABLE FORAGE PLANT FOR MILCH COWS.

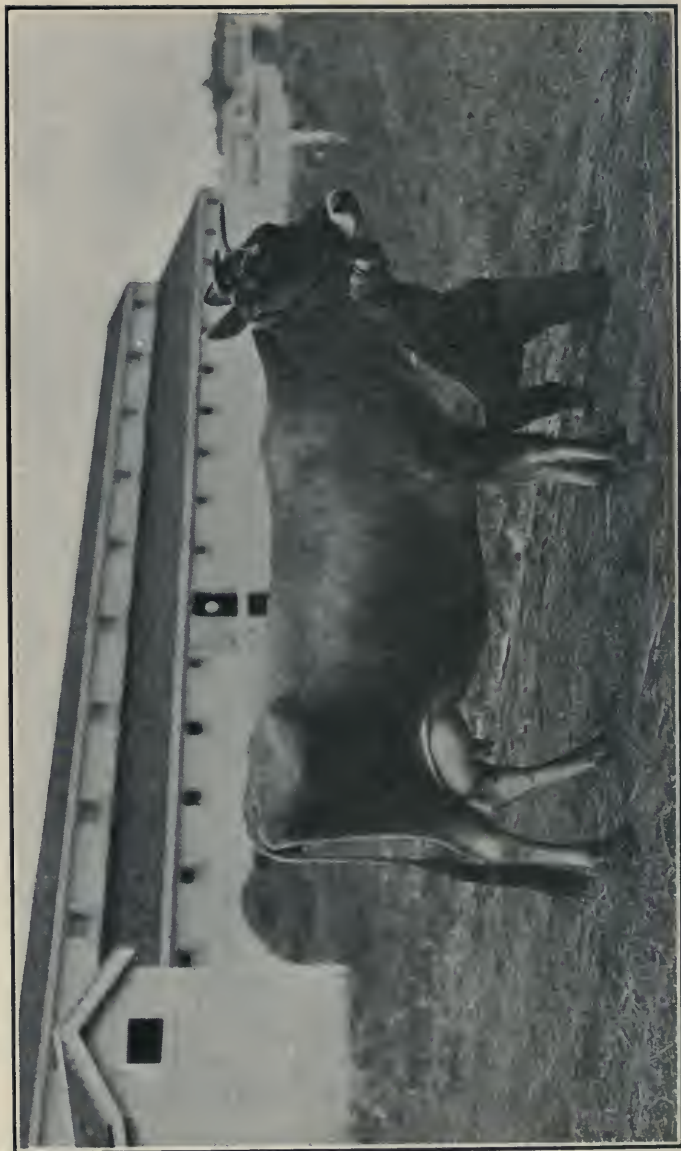

98. JERSEY COW—"ORFORD VIXEN."

CHAPTER XXV.

CATTLE FOR BEEF.

The beef breeds of cattle are entirely different from the "wedge-shaped" dairy breeds. In the first place, their general form is broad, deep, smooth and even, with parallel lines. Next in importance is a thick, even covering of the right kind of meat in the parts that give the high-priced cuts. Broad, Beef Breeds.



99. SHORTHORN HEIFER—"NONPAREIL BUD II."

well-covered back and ribs are necessary, and no other good point will compensate for the lack of this quality. A good feeding animal should handle soft and mellow and have a vigorous constitution, which is indicated by a broad chest, well sprung ribs, large heart girth, and general robust appearance.

The Shorthorn (*see Ills. 99-100*) has more admirers in this country than any other of the beef breeds, Shorthorn
(Durham).

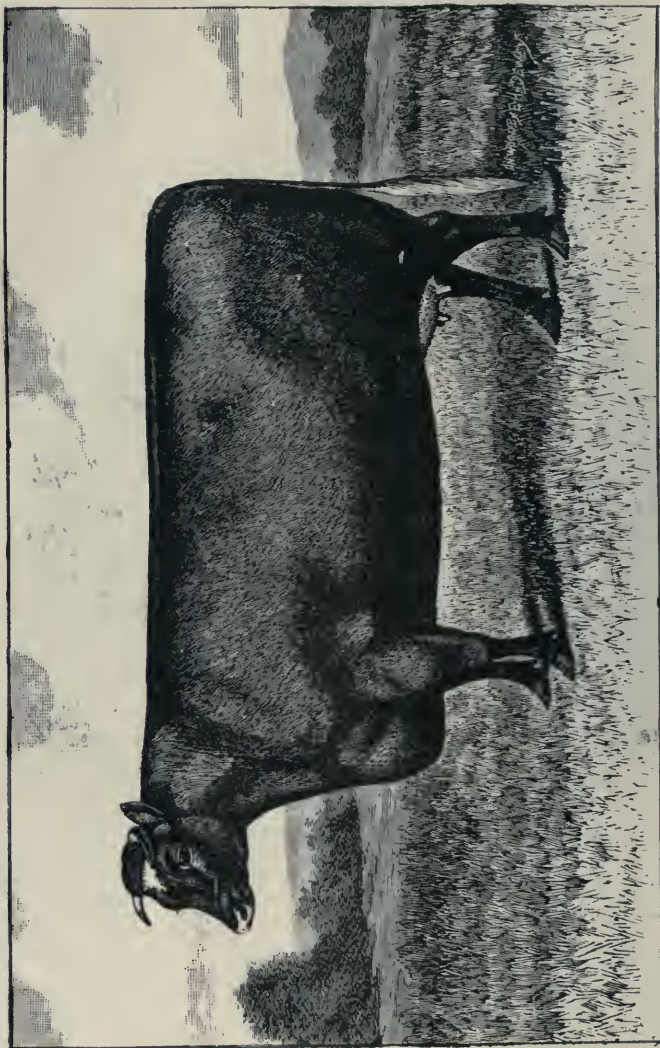

100. COW—SHORTHORN "DURHAM."

and in cross breeding the prepotency of the sire is more pronounced than that of any other of the beef breeds. A marked change in market demand has taken place of recent years, the consumers now calling for early maturity, with a plump carcass of medium weight and minimum offal. Large, rough and patchy animals are no longer wanted.



101. SAVE THE CALVES.

The Hereford (*see Ill. 102*) is similar in conformation to the Shorthorn, and, like the latter, have been bred for beef; consequently they are seldom kept for dairy purposes. Their native home is Herefordshire, England. Their color is red with white face and white points. Formerly the horns were long and turned up. The present fancy is for Hereford.

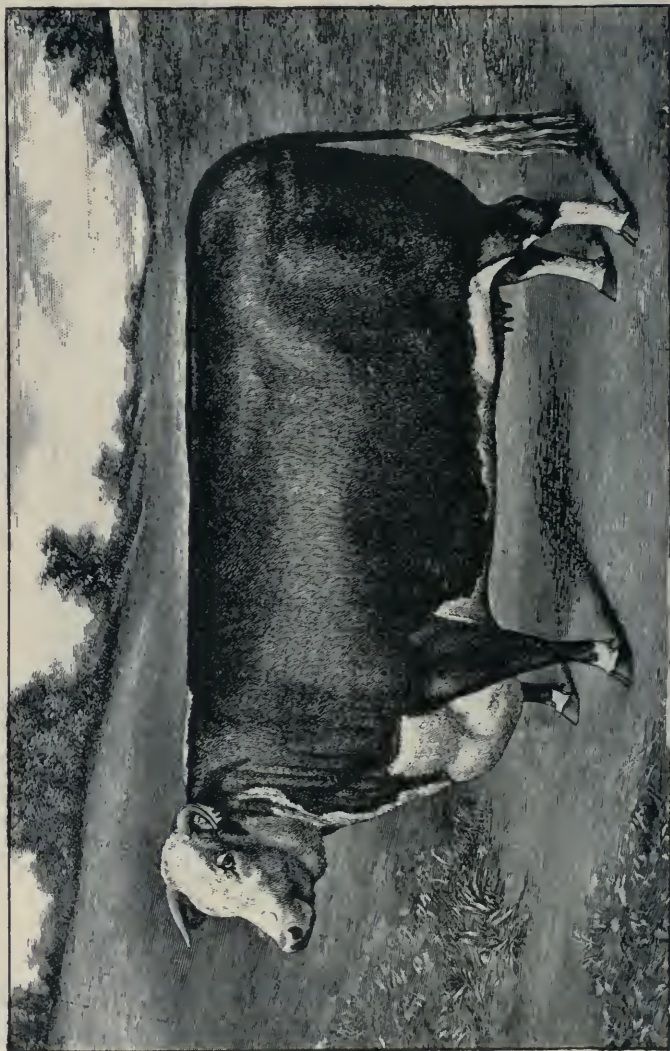

102. HEREFORD COW.

shorter horns and turned down. Herefords are excellent grazers, and a herd of this breed has an attractive appearance.

The Aberdeen Angus (*see Ills. 103-4*) is another of Aberdeen
Angus.



103. ABERDEEN ANGUS HEIFER—1ST PRIZE.

the popular beef breeds of cattle. As the name indicates, the native home of the breed is Aberdeenshire, Scotland. The color is black, and animals are without horns. For quality of flesh they have no superior. They have been bred for beef; consequently are not intended for the dairy.



104. ABERDEEN ANGUS COW.

There are other beefing breeds of cattle, viz., Galloway, Sussex, Devon and the Highland Cattle. These all have certain good qualities, but on account of their smaller size have not become generally popular.

Galloway,
Sussex, Devon
and Highland.

Calves of the beefing breeds require better care and feed than the dairy breeds. In order to get the best and quickest returns it is advisable to feed them whole milk for one or two months. This should be followed with good, succulent food, com-

Care of Calves.



105. PORTERHOUSE ROAST.

posed of clover, rape, roots, bran and silage. Little grain should be fed until the frame is developed.

With good comfortable stabling and abundance of fodder, roots and coarse grain, it is advisable to manufacture the feed into beef on the farm by buying two-year-old steers (of the beefing type) in the fall, for winter feeding. For this purpose, select only young animals, blocky, smooth, with wide backs and loose hides, weighing between ten and eleven hundred pounds. They should be finished in six months, weighing then thirteen hundred pounds or over.

Buying Steers
for Winter
Feeding.

CHAPTER XXVI.

HORSES.

Horses on the Farm.

In rearing horses the farmer should have two objects in view, viz., rearing for his own use, and for the market. The ordinary farmer should confine himself to heavy horses.

Modern Clydesdale.

The modern Clydesdale (*see Ill. 106*) is a smooth animal and of general good quality. There is an advantage in starting with registered mares, so that their line of breeding may be traced back for several generations. If there should be a strain of the fleshy, coarse-legged type, have nothing to do with them.

Grade Mares.

For grade mares whose breeding is unknown there should be used only a registered sire whose ancestors are of the smooth type, and himself of good quality from the feet up.

English Coach Horse.

Another breed of horse suitable for the farmer is the Cleveland Bay, or English Coach Horse. This is a most useful general purpose animal for the farmer and for the market.

Demand for Coach Horses.

At the present time there is more demand for heavy coach horses than for any other type. In selecting brood mares, give the preference to those that are registered. Other things being equal, select large and stylish animals, with good knee action. Use only a registered stallion whose line of breeding is of the right type, one full of quality and knee action.

English Shire.

For heavy dray work the English Shire is the most popular horse. In Liverpool and London, England, it is quite common to see three of those



106. CLYDESDALE HORSE.

monster animals, each weighing over a ton, hitched tandem to a large dray (waggon).

Hackneys and Roadsters.

The Hackneys and Roadsters are fancy animals, too small for farm work.

The thoroughbred race horse, and the trotter, are for the sport.

The mongrel cross-bred horse is usually a disappointment.

Care and Feeding of Horses.

The winter ration for farm horses that are working moderately should be cut clover, timothy, hay and corn silage, mixed a few hours previous to feeding. This should be fed morning and evening, all that the animals will eat in an hour and a half, with two pounds of crushed oats and one pound of bran (mixed) at each feed. At noon give cut hay and fifteen pounds of whole roots.

Summer Ration.

For summer ration, when horses are working hard, give cut timothy and clover hay and silage (mixed), all they will eat in an hour and a half, three times each day, with four pounds of crushed oats and one pound of bran mixed. Water before and after feeding. Clover hay is a flesh former, and is especially suitable for horses that are working hard, but it must be properly cured and not musty.

It is advisable to moisten the feed with silage, pulped roots, or lime water. Hay cut in a cutting box should be cut long for horses, to prevent irritation of the stomach.

CHAPTER XXVII.

SHEEP.

This country is specially adapted for the rearing of sheep, on account of the clear and dry atmosphere, and sheep are not here subject to the diseases that are prevalent in those countries where the atmosphere is more humid.

Various Breeds of Sheep.

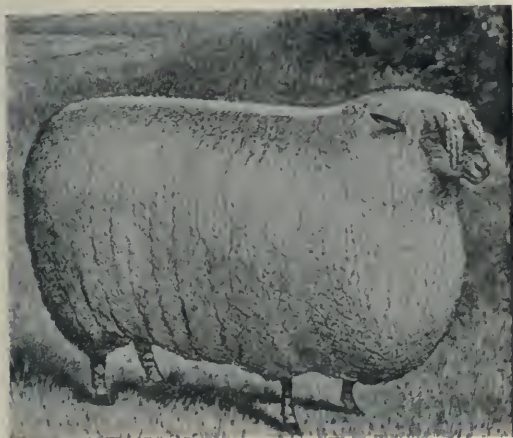

108. COTSWOLD.

There are breeds to select from which are suited to the various circumstances and conditions. The farmer must decide this question for himself.

Select According to Conditions.

If the farmer is prepared to give the necessary care and attention, the chances are that one of the long-wool breeds will be most profitable; but he must be prepared to house these in rainy weather, or their wool, which is long and open, will hang on the animals like a wet blanket, and this is very injurious.

Special Care for Long Wool.

Cotswold
Described.

The largest of the long-wool breeds is the Cotswold. *See Ill. 108.* Cotswolds are well proportioned, and lay on flesh evenly. They have a prominent crest of long wool on the head, and are well covered below. An ordinary flock of Cotswolds will yield an annual fleece of wool of from thirteen to fourteen pounds each.

Lincoln.

The next in order is the Lincoln. *See Ill. 109.* This is a more compact animal. The body is evenly



109. LINCOLN.

covered with flesh and long curly wool. There is a crest on the head. The annual yield of wool is equal to that of the Cotswold.

The other long-wool breed is the Border Leicester. *See Ill. 110.* This is an attractive, upstanding and lengthy animal, with clean head and legs, wool usually in ringlets. One objection to these animals is that they are liable to get bare below at an early

age. They are noted for a good covering of flesh on the back and ribs. Their average clip of wool is about two pounds less than that of the Cotswold and Lincoln breeds.

The English or Blue-face Leicester is more blocky, with a heavier fleece, and is better covered below.



110. BORDER LEICESTER.

The Downs, or fine-wool breeds, will endure exposure to rain and damp weather better than the long-wool breeds, on account of their fleeces being more dense.

The Down Breeds.

The Oxford Down (*see Ill. 111*) is a heavy, compact sheep, with medium wool, and a crest on the head, with brown face and legs. This and the other Downs are noted for a superior quality of mutton. The average weight of wool from a flock is from eight to nine pounds.

The Oxford Down.

Shropshires.

Next in order of the fine-wool breeds is the Shropshire. *See Ill. 112.* This is a very compact animal, full of quality, both of flesh and wool. The wool is of a fine silky texture, with which the entire body is covered. The face and legs are dark. The average weight of fleece is from eight to nine pounds.

The South Down.

The most compact and hardy of all these breeds is the South Down. *See Ill. 113.* This is a smaller animal than the other breeds, but the deficiency in

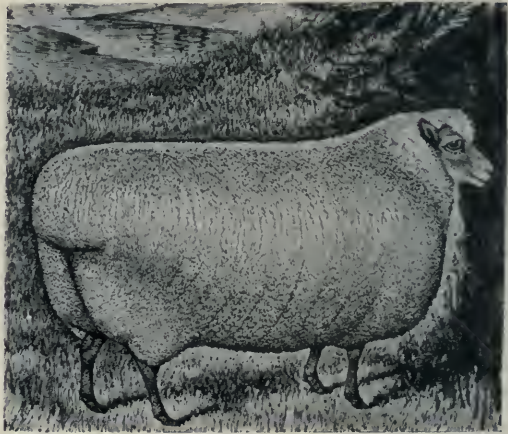

111. OXFORD DOWN.

size is made up in quality, both of flesh and wool, which are superior to those of any of the other breeds. The average weight of fleece is from seven to eight pounds.

Other Breeds.

There are other breeds, as the Dorset, Hampshire, Suffolk, etc., each having their special characteristics.

For the first it is claimed that they will raise two crops of lambs per year, but this is not practicable.

Again, having horns, they are said to be able to take care of themselves against dogs.

For the dog nuisance, lead is more effectual, and every farmer who has a valuable flock of sheep should keep a loaded gun in a convenient place, and when he finds a dog chasing his sheep he should shoot it, depending on the law for protection.

Shoot Dogs.



112. SHROPSHIRE.

The feeding and exercise of breeding ewes requires special attention. In the autumn, when being mated, they should receive extra food. Nothing is better than a feed of rape each day. It is advisable to have lambs come early in the spring, provided the ewes have a warm pen. The lambs should have a compartment in the pen (arranged so that the ewes cannot get in), and where they can receive extra feed of pulped roots, cut clover, bran, bruised oats and ground flax (mixed). The lambs should be docked when a week old.

Feeding of Ewes.

Early Rape.

Have some early rape ready for them by the middle of July (weaning time), so as to keep them growing and so develop a strong, healthy frame.

Dipping Sheep.

Soon after lambing, the ewes should be shorn, and both the ewes and lambs dipped with one of the commercial dips (following the printed directions). Ewes and lambs should also be dipped in the autumn.



113. SOUTHDOWN.

Winter Care.

In winter sheep require a dry and thoroughly ventilated building which is not too warm, but free from draughts; not too many in a pen. See plan of sheep house (*Ill. 35*). The breeding ewes should have daily exercise, either in a yard or field.

Feeding Sheep.

Feed morning and evening the following mixture, prepared a few hours before feeding: Cut clover (salted), pulped turnips, silage, and a little bran. The quantity fed should be what they will eat in an hour and a half. Noon ration: Pea straw or clover hay, fed outside in racks. See *Ill. 38*.



114. SOUTHDOWN SHEARLING EWES.

Those farmers who prefer not to breed sheep, but to follow the system of winter feeding, should buy a sufficient number of wether and ewe lambs to fill the sheep house in the autumn. For the first two months feed according to the directions given for breeding ewes, then for finishing add to the mixture a little chopped grain, peas, barley and oats. This method as a rule is very profitable. On no account buy old sheep to feed, unless it is for soap grease.

Winter
Feeding.



115. HAMPSHIRE LAMBS.

CHAPTER XXVIII.

SWINE.

Swine.

During recent years all the popular breeds of swine have undergone a change to suit the trade, which now calls for juicy flesh instead of fat. The big fat hog has had to give way to one of an entirely different type (*see Ill. 117*), one with larger body



FIRST PRIZE RAM LAMBS.

and hams for the most expensive cuts, and less width on back. *See Ill. 119.* The hog should carry its width evenly from shoulder to tail, with light shoulder and jowl, as these are cheap cuts.

The change noted was first brought about by a desire to cater to the trade of Great Britain, which demands pork of a fleshy and better quality. Our home trade is also undergoing a change in the same direction. The fat pork that was popular some



117. TYPICAL BACON HOG (SIDE VIEW).

years ago is no longer wanted. The fat on the back must not exceed one and a half inches thick. What is wanted is a fleshy hog, about eight months old, and rather under than over two hundred pounds.

Change of
Type.

While great progress is being made in the change of type, still, so far, none of our present breeds of swine conform exactly to the ideal aimed at. To fix a type will take years to accomplish, even by our



OXFORD DOWN SHEARLING EWES.

most expert breeders, and whether this will be by cross-breeding or through one of our present breeds is difficult to say.

Feeding Swine.

Even after we have got the typical hog the work is only half done. The compounding and preparing of foods to produce the best quality of flesh is yet in the experimental stage, and will evidently take some time before the results will be entirely reliable, so as to produce a uniform good quality of flesh.



119. TYPICAL BACON HOG (FRONT VIEW).

**Feed for
Young Pigs.**

In order to keep young pigs growing after being weaned, they should be given a certain quantity of skim milk, along with other feed, which at first should be composed largely of middlings with a little ground flax-seed. When about three months old, add bran, pulped roots, and green clover or rape, and a little ground grain, peas, barley and oats, mixed. In winter, alfalfa clover should be cut and scalded for them. Mix the whole together, and feed a limited quantity morning, noon and evening. When the pigs are five or six months old increase the grain, and feed less of the bulky food.

**Feed for
Finishing.**

For the last six weeks, in finishing, the morning and evening rations may be largely of chopped grain, including corn. Do not give more than they will consume in one hour. At noon feed sugar-beets or mangel-wurzels raw, without grain. This system of feeding keeps the pigs in a healthy and growing condition, and makes a juicy quality of flesh.

Salt and Ashes.

During the winter, when housed, hogs require old sods, also salt and hardwood ashes, with proper care and feeding. No animal on the farm will give quicker returns than the hog. Neither will any yield larger profits, provided too many are not kept and skill is used in the feeding. The best returns are obtained where hogs are used to turn to account the by-product of the dairy, the gleanings of the field, and products which would otherwise be wasted. The free use of alfalfa, either in winter or summer, will also greatly add to the profits which may be made.

Brood Sow.

To get the best results from a brood sow she should receive kind treatment, so that she will be gentle and kind. This has a very good influence on her offspring. With proper care the sow will raise two litters per year, say March or April and

September or October, rearing on the average from seven to eight pigs each time. As this means a heavy drain on the system of the sow, she will require to be fed accordingly.

In winter, feed skim milk, bran, pulped roots and chopped grain, morning and evening, and at noon sugar beets or mangels only. Exercise is necessary, but she should not be turned out of doors in very cold weather. As a substitute for skim milk

Winter Food
and Exercise.

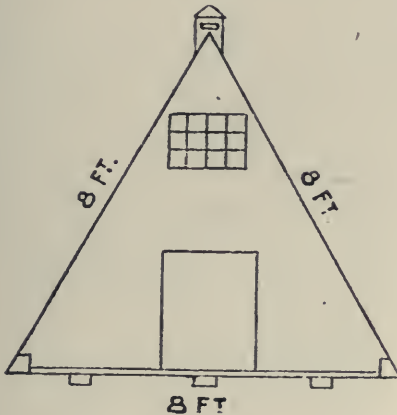

120. PORTABLE PIG HOUSE.

fill a barrel or milk can with hot water, stir in a little middlings, oil-cake and chopped grain, and cover over for a few hours. Pigs, both young and old, should have in addition all the pure water they wish to drink.

In summer, young growing pigs should have the run of a clover patch, but when finishing for market keep them in the house where they will be comfortable and clean.

Summer Food
for Swine.

Portable Pig Houses.

The brood sow should have the run of a clover patch in summer. A small portion of the clover field may be hurdled off and a portable pig house (see *Ill. 120*) constructed to shelter the animals from the hot sun and storms. Each brood sow should have a separate enclosure and a portable house in which to rear her young in summer. The same style of house may be used for the young pigs during the summer. In order to get the best results it is necessary to provide shelter in the clover or rape pasture during the summer season. A pair of horses will haul the portable pig house wherever required.



TRUE DWARF ESSEX RAPE.

CHAPTER XXIX.

POULTRY.

Poultry are kept on most farms, but, as a rule, receive indifferent treatment. Seldom have the fowls a house to protect them from the storms and cold weather, and they are allowed to roost out-of-



121. FEEDING TIME. WHITE LEGHORNS.

doors, on implements, fences, trees, etc., in all kinds of weather. When a house is built for them it is frequently quite unsuitable for their health and comfort, so that the results are not satisfactory.

For plan of hen house, with modern conveniences, see *Ill. 27* and end view (*Ill. 28*), showing position of nest, roost, and feed trough. This is on the south side of the implement house, and

Plan of Poultry House.

isolated from the cattle stables, which is desirable. The size of the building here drawn is twelve feet wide by fifty-two feet long. This can be made shorter or longer according to the requirements. There is a passage of three feet on the north side. The balance is divided, with wire netting, into six compartments, which are eight and a half feet square. These are of ample size for ten or twelve hens each. The roof over the passage is nine feet high with a fall of six inches. This is covered with inch boards, tar-paper and shingles, or ready roofing. The main roof is seven feet high, next the passage, and is covered with inch boards, tar-paper and shingles, or ready roofing. The south side is two feet high, sheeted on the outside with tar-paper and boards. From the top of this lower wall to the main roof are window frames three feet high. The inside of the poultry house, including sides, ends and roof, should be sheeted with matched lumber. The inside of the poultry house should be white-washed every spring. Take out the glass and tack muslin or cheap factory cotton over the openings at the same time. This will admit fresh air, and will not attract the heat from the sun during the summer season. Some expert poultry men use cotton or muslin instead of glass during both summer and winter with satisfactory results. Openings near the roof and covered with muslin or cotton are an advantage in keeping the poultry house dry in winter. This admits fresh air and allows the foul air to escape.

**Feed and
Water Trough.**

The feed trough is placed in the passage, and provided with round uprights, two inches apart, or sufficient for the fowl to put their heads between to feed. They may be watered in the same way. Nests, roosts and board for droppings should be



122. WAITING FOR MEAL TIME.

moveable. The latter can be made to tilt into a box or wheel-barrow in the passage. Every precaution should be taken to make the poultry house frost-proof in very cold weather. Artificial heating is only required in one room for early chicks.

Winter Eggs.

Pullets will commence to lay when eight months old, say at the beginning of November, and continue laying all winter, or during the time when fresh eggs are a much higher price than in summer. In a flock of fifty or sixty hens the difference amounts to considerable. The object should be to raise early chicks for laying in winter instead of summer.

Disposing of Poultry.

Arrange to keep the pullets for two winters, and with proper care and feeding they will be in good condition for table use in the months of May and June, after their second winter's laying. At this season of the year even old hens bring high prices. The male chicks should be fattened and sold when four or five months old.

How to Feed.

At first feed bread crumbs or rolled oats, then ground corn, peas, barley and oats, mixed with skim milk; also give ground bone and flesh, with green vegetables or roots. When fattening, confine to a small pen; furnish all the grit and pure water they wish. Give all the feed they will eat, and keep them free from vermin by using some insecticide or kerosene.

Care of Hens When Laying.

To get the best results from hens in producing eggs, induce them to take plenty of exercise by scattering their food, composed of corn, peas, barley, oats and wheat, among chaff, so that they will have to scratch for it. In winter they should receive a liberal ration of cut clover, ground bone and flesh; also middlings, mixed with skim milk, and all the vegetables they wish, such as cabbage, sugar-beets, etc. Grit and pure water should be in abundant supply at all times.



123. BRONZE TURKEY. A STATELY CHAP.

Dust Bath.

The floor in the southern portion of the pen should be covered with coarse sand, for the fowl to take a dust bath. This is necessary to keep them clean. In summer hens should have the run of a paddock of green sward enclosed with a woven wire fence.

Trees for Shelter.

The paddock may be planted with groups of evergreen and deciduous trees for shelter from the hot sun in summer. In the plan (*see Diagram 54*),



MADE IN FOUR
SIZES.

390-400 Egg Standard Cyphers
Incubator.



MADE IN TWO
SIZES.

120-130 Egg Superior Hot-
water Incubator.

124. MODERN INCUBATORS.

provision is made so that the portion of lawn between the house and hennery, nearly an acre, may be enclosed for this purpose. Digging underneath the trees will help the growth of the latter and make dust baths for the fowl.

When to Mate.

The hens selected for breeding purposes should be mated about ten days before eggs are wanted for hatching. After the breeding season is over either kill the male bird or keep him by himself. According to experiments, hens lay more eggs of a superior flavor and better keeping quality when kept away

from the male. Hens should be set in a secluded place and food and fresh water should be constantly within their reach.



125. CYPHER'S BROODER—"B" STYLE, FOR OUTDOORS.

In preparing a nest, first put in the bottom a thin sod, and over this a sheet of tar-paper. This will keep away lice. After this some chaff is all that is necessary. When only a few fowl are kept,



126. PORTABLE HOVER.



127. ADAPTABLE HOVER.

nothing more is required than a hen to do the hatching and caring for young chicks.

When poultry constitute one of the special departments of the farm, and are kept with a view to making money, the incubator (*see Ill. 124*) has

Poultry a
Specialty—
Incubator
Necessary.

advantages over the hen. If a hundred eggs are ready for setting beginning of February, it might be difficult to get the necessary number of broody hens at that season, whereas the incubator can be got ready in a few minutes, and the hatching done quite satisfactorily. Manufacturers furnish printed instructions with each machine.

Advantage of
Brooder.

The first two weeks is the most critical period in rearing chicks. The self-regulating nursery



128. HATCHING CHICKENS BY ELECTRICITY.

ELECTROBATOR.—An Electrically Heated and Regulated Incubator, designed expressly for poultry keepers who require small hatching capacity.

Economy in labor, convenience in location, no troublesome fumes or gasses, perfect distribution of heat in the egg chamber; simplicity and accuracy of regulation. The demand for these Incubators last season was quite unprecedented and gave every satisfaction. They are not toys, but simple, economical, useful and satisfactory Hatching Machines.

brooders or Hovers (*see Ills. 125, 126, 127*) are particularly valuable for the purpose. For summer, a simple outdoor brooder (*see Ill. 130*) may be used.

Breeds of
Poultry.

There are long lists of distinct breeds of poultry, each having its own special peculiarity and advantage. The following breeds are specially noted as egg producers: Andalusians, Minorcas, Spanish,

Leghorns, Houdans, Dominiques, and several of the Game breeds. The above breeds are of various forms and colors.

By general purpose we understand it to be those breeds of fowl especially adapted for early maturing for table use and for winter laying. The oldest of these are the English Dorking. Later we have the Bar Rock (*see Ill. 129*), Buff Plymouth Rock, White Wyandotte (*see Ill. 131*), and Buff Wyandotte (*see Ill. 133*). The latter is very attractive, and likely to become popular.

General
Purpose
Breeds.

With proper management no branch of the poultry business will give larger and quicker returns than duck raising. The Pekin variety (*see Ill. 134*) is one of the best. The Aylesbury, a pure white duck, has many admirers.

Management
of Ducks.

The Pekin is of a creamy white color. This duck will lay over one hundred eggs in a season.

For breeding, put one drake with five or six ducks, first of December. Do not set the first ten or twelve eggs. A portion of the poultry house (*see Ill. 28*) is suitable for ducks, except that the roosts are not necessary. Instead, keep the floor of the pen covered with clean litter. Ducks require only about half the space that hens do.

Ducks should have a portion of the lawn or paddock for a run for exercise the same as hens, but should be kept separated from other fowl by a woven wire fence.

Lawn for
Exercise.

Duck eggs may be hatched under hens or with an incubator. The care and feed of ducklings is the same as described for chicks.

Hens vs.
Incubator.

Ducks should have all the fresh water they wish to drink, but the trough should be protected by uprights, so that they can only get their heads in between. It is not necessary that they should get

Water and
Feed.



129. BARRED PLYMOUTH ROCKS.

into the water with their feet. They should be supplied with an abundance of green feed and grit.

Grain fed to ducks, old or young, should be ground and mixed with skim milk. Aim to have as many early ducklings as possible, as these will command the highest price.

Ducks should be ready for market when between nine and ten weeks old, weighing at that time from four to five pounds each.

Ground Grain
and Skim Milk.

Time to
Market.

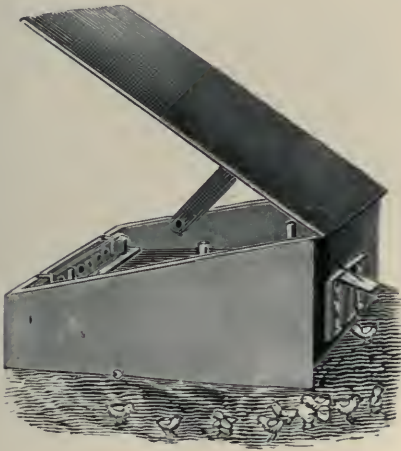

130. OUTDOOR BROODER.

In finishing ducklings for the market it is advisable to give one feed each day of celery during the last week. This imparts a pleasant flavor to the flesh.

The individual farmer must decide whether geese should also be kept. Under certain conditions these may be made profitable, and that would be as a specialty. However, it may be said that, for the

How to Finish.

Geese a
Specialty.



131. WHITE WYANDOTTES.

best results, every department of the farm should be made a specialty.

The favorite breeds of geese are the Toulouse, a large gray, and the Emden, a large white. A young goose will lay about twenty eggs in a season, and an old goose from thirty to thirty-five. In mating, put two to three geese with one gander.

Breeds of Geese.

Geese do not thrive in close confinement. They require the freedom of a large paddock. The eggs

Require Freedom.



132. EVERYBODY RAISES GESE.

hatch in thirty days. The goslings require the same treatment and feed as ducklings.

It is not necessary that they should have water in which to swim, but they should at all times have a supply of fresh water to drink.

Fresh Water.

It is advisable to rush the goslings and sell them as soon as well feathered, say when they are two and a half months old. They should then weigh from twelve to fifteen pounds each. This is the most profitable time to sell.

When to Sell.

The turkey is left to the last in this work. Of all

The Turkey.



133. BUFF WYANDOTTE.

domestic fowl the turkey is the most noble. The old gobbler is monarch of all he surveys.

The Bronze variety is the largest and most popular. The White Holland has also many admirers. **Varieties.**

A shelter should be provided for turkeys in winter, but it must be roomy, and the roosts from eight to ten feet high.

Turkeys will not thrive when closely confined. They should have the freedom of the farm-yard during the winter. Turkey hens are not expected to lay until the end of March or the first of April. For use, feed a little grain, peas, barley and oats, mixed. In addition, give cut clover, moistened, and roots. **Allow Freedom.**

In mating, put about a dozen hens with one gobbler. **Mating.**

Young turkeys are rather difficult to raise at first, but with a warm coop or brooder, having a small pen attached, there need be no loss. **Young Turkeys.**

Turkeys hatched in June should weigh from twenty to twenty-five pounds for Thanksgiving and Christmas. **When to Sell.**



134. PEKIN DUCKS.

CHAPTER XXX.

WESTERN FARMING.

Having set forth the method of cultivation and rotation of crops especially suitable for Ontario, the Maritime Provinces and British Columbia, a lesson on the Canadian West will now be quite in order. This immense territory is bounded on the south by the United States, on the north by the Peace River District, on the west by the Rocky Mountains, and on the east by the Hudson Bay.

The Canadian
West.

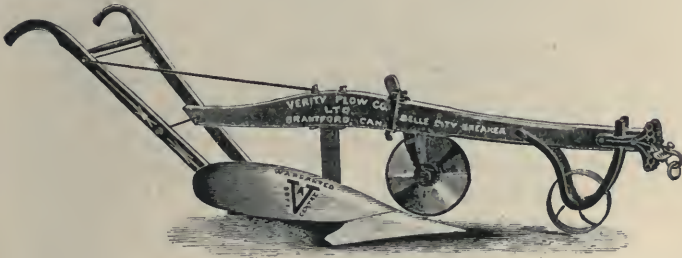

135. BREAKING PLOW.

The vastness of this extent of territory can scarcely be comprehended. It is estimated that there is within its bounds sufficient land to give every inhabitant in the world at the present time (1916) half an acre each.

Nearly the whole West is well adapted to grain growing, and especially spring wheat.

As conditions here differ from the eastern Provinces, it is necessary to make some changes in the mode of cultivation and the style of implements most suitable for the country.

In starting on a prairie farm (in its natural condition) in the spring, the farmer should plow early three or four inches deep, using a breaking plow (see *Ill. 135*) with two or three oxen or horses as the case may be. Roll soon after plowing, with a heavy roller, then harrow to conserve moisture. See *Ill. 46*. Sow a few acres with spring wheat soon as thoroughly prepared. This may be used for bread the first year. A few acres should also be sown with oats to feed the animals, not later than the end of May. Potatoes may be planted, and vegetables and swede turnip seed should be sown for winter use.

It is important to keep the breaking plow going. On this depends the following year's crops. Continue to roll and harrow after plowing to conserve moisture. The sod will rot much sooner.

The portion that has not been cropped will require to be back-set in the autumn by plowing about one inch deeper than the first time; then thoroughly harrow. The portion that was cropped should be gang-plowed three or four inches deep, and harrowed. This will level the land and leave it in good shape for early seeding, which is important in this north country where the summer season is short.

Wheat, oats and barley, in the order named, should be sown in spring soon after the snow is off the land and the frost is out one or two inches. Grain sown while the frost is in the subsoil will make more rapid growth on account of the moisture caused by the thawing out below. A new settler, commencing with limited capital, usually sows the grain by hand, but as soon as possible he should get a grain-drill, so that the grain may be planted at a uniform depth. This is especially necessary on the prairies, where the roots of the young plants are liable to get uncovered with the strong winds.



136. THREE-FURROW GANG PLOW.

The most suitable grain drill to use, where it is necessary to sow before the frost is out of the ground, is the double disc drill. *See Ill. 137.*

As soon as the wheat and oats are harvested the stubble land should be gang-plowed three or four inches deep, and harrowed with a lever harrow which provides for the teeth to be set at an angle (to prevent clogging). *See Ill. 76.* It is necessary

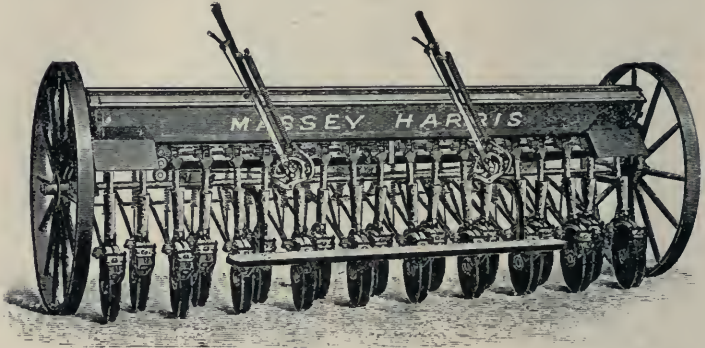

137. DOUBLE DISC DRILL.

to level all land in the fall which is intended for early seeding the following spring.

While the autumn is a very busy season of the year, the fall plowing should not be neglected. With a three-furrow gang plow, one man and three or four horses (according to the nature of the soil) can plow from four to five acres per day. *See Ill. 136.* Rolling coulters are preferable to the ordinary straight coulters, as they are not liable to clog with the stubbles.

Rolling down long stubbles before plowing prevents clogging. It might be stated in this connection that the more stubble there is left on the land to

plow under the better, as this forms vegetable matter for plant food and conservation of moisture for the succeeding crops. The upper portion of the straw and chaff can be used for fodder.

A farmer cannot afford to burn straw, as it is too valuable for the soil.

After the first or second year, five pounds per acre of red clover seed should be sown with all the grain crops and plowed under with the stubble in autumn in order to keep up the fertility of the soil. It would be advisable to sow two or three acres with red clover the first year as an experiment. If the clover does not grow it may be for the want of the proper bacteria in the soil, and the following spring sufficient nitro-culture should be ordered from one of the agricultural colleges to treat a few pounds of red clover seed, and this sown according to directions received with the culture. Afterwards the inoculated surface soil can be used to treat other portions of the farm. Clover will not grow on low, wet land.

A three years' rotation would be suitable for the West (after the soil has been treated with the clover culture), viz., two years, grain; the second grain crop being seeded with ten pounds red clover and four pounds orchard grass. This gives hay or pasture the third year. Early in the autumn plow the clover sod about four inches deep; then roll and harrow thoroughly, so that the surface will be level and in good shape to sow with grain early the following spring. This system should keep up the fertility of the soil indefinitely.

Not the least important matter in this western country is the planting of trees on the west and north of the home as a protection from the cold winds in winter.

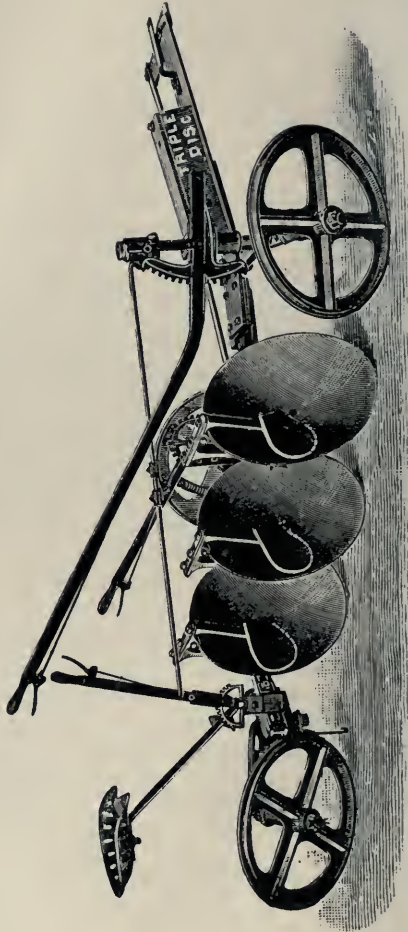

138. DISC GANG FLOW.

Flax is destined to be an important crop in the West. It can be grown to perfection on newly-plowed prairie sod by the following method: Plow the sod early in spring about four inches deep; then roll and harrow. In a few days cultivate with a spring-tooth cultivator or disc gang plough. *See Ills. 47 and 138.* Again harrow to make a fine tilth on the surface. Flax Culture.



139. PULLING FLAX.

Flax should be sown the early part of May either with a disc drill or a broadcast seeder (*see Ill. 140*), at the rate of half a bushel per acre. If sown on the surface with the latter, harrow with the lever spike-tooth harrow to cover the seed. Seeding.

The time to harvest flax is when it is quite ripe. It is not necessary to bind flax, but rather cut it with a self-rake reaper (*see Ill. 80*) and handle it loose. An average crop of flax seed is from 12 to 20 bushels per acre, according to the condition of the Harvesting.

soil. There is a cash market at a price considerably more than wheat.

Advantages of Growing Flax.

Flax rots sod better than the common method of plowing in spring and back-setting in autumn, and it is not so liable to get frosted as spring wheat or oats. After the flax is harvested, all that is necessary is to cultivate or disc and harrow the land for wheat the following spring.

If labor were more plentiful there would be as much money realized from the fibre as the seed, and this would make flax growing a very profitable business.



140. BROADCAST SEEDER.

Semi-Arid Lands.

In the West there are dry districts which require special treatment in order to grow crops of grain successfully. Shallow cultivation must be adopted in order to keep all the vegetable matter on the surface so as to conserve and retain moisture in the soil. This is in accordance with the laws of nature. Early in the spring the land should be gang-plowed shallow, then rolled, and harrowed with a spike-tooth harrow. Presuming that the surface is now fine and mellow after this preparation, sow a mixture of oats and peas, one bushel of each. (Vetches may

be used instead of peas.) Sow with a double disc seed drill. *See Ill. 137.* This style of a drill will press a crease in the soil and plant the grain on the firm soil below, which will start capillary action of the moisture in the subsoil so that the grain will get all the moisture necessary to start.

In order to prevent evaporation of the moisture in the soil it will be necessary to loosen the surface soil every week or ten days with a lever spike-tooth harrow (*see Ill. 76*) to form a mulching until the crop shades the soil from the hot sun. Soon as the peas or vetches, as the case may be, are in bloom, plow shallow, turning the whole crop under the furrow by attaching a chain to the centre of beam of plow and the outer end of evener behind the furrow horse, forming a loop. It will be necessary to use a rolling coulter. After plowing, roll and harrow.

This work should be done before harvest. After harvest, spread a few loads of farm yard manure per acre over the surface with a manure spreader. *See Ill. 50.* Leave this manure spread on the surface as a mulching and to prevent the soil from drifting. In the following spring sow wheat or oats early, soon as the frost is out of the ground about two inches, with a double disc drill. The idea is to plant the grain on the frozen subsoil so that it will get abundance of moisture. While the ground is thawing out, the manure on the surface will act as a mulching and prevent the moisture from escaping. It would be advisable to sow a few pounds of red clover per acre at the same time as sowing the grain. As there is not likely to be any of the proper bacteria in those arid soils, it will be necessary to have the red clover seed treated with nitro-culture, which can be had from any of the agricultural colleges with

full directions for using. By plowing this clover and long stubbles under in the autumn (shallow), using the chain and rolling coulter, rolling and harrowing as before described.

By following the above directions and adopting a short and systematic rotation of crops, in which red clover forms a part, there should be no difficulty in keeping up the fertility of the soil.

CHAPTER XXXI.

SYSTEM.

Whether it be in Ontario or in the West, "system" is all-important on the farm as well as elsewhere. There should be a system on the farm the same as in the factory or in a business office. Systematized work saves time and labor. While it is necessary to rise early in the morning on the farm, it is equally necessary to quit work at six o'clock in the evening, so that there will be sufficient time for reading and enjoyment. Every farmer should subscribe for one or two agricultural journals, a religious paper for Sunday reading, and a daily newspaper, so that it will not be necessary for any member of the family to go to the store or tavern for the news of the day. Every member of the family should have an opportunity of reading for himself, or herself, and keep apace with the times. The present age demands knowledge in all things. Less manual labor and more thought would bring many farmers better results than they now enjoy.

Every farmer should also keep an account of all his receipts and disbursements, and at the end of each year take an inventory of all his stock, grain, implements, produce, etc., on hand at their current values. To this should be added the cash in the bank and on hand, as well as all accounts and notes receivable. This will show the total assets. From the total the full amount of all accounts and notes payable should be subtracted, and the result will show the farmer's present standing. It is also necessary to keep a record of the results produced

Keep Accounts

by each crop. Any crop for which the returns do not exceed the cost of production should be discontinued if the cause of loss cannot be removed, and no animal should be kept unless it gives a profit over the cost of food and labor necessary for its maintenance.

In short, a farmer, to attain the highest measure of success, must know how to produce the largest quantity of grain or other crops per acre, how to turn this to best account in the finished product of the farm, and how to market that product to the best advantage.

But if the qualifications demanded are of a high order, the rewards are much more certain than in other lines. Farming is a more interesting, healthful and independent calling than any other. While the percentage of failures in business life is large, the percentage of failure in agriculture is small. And the ideal of a happy home alike chosen by poet and artist is almost invariably found amid the green fields and wooded slopes of the open country.

LIST OF ILLUSTRATIONS

PORTRAIT OF AUTHOR *Frontispiece*

NO.	PAGE
3. Brush Harrow	14
4. Chain Harrow	15
8. Cold Frame	22
1. Four-horse Subsoiler	10
2. Home—North View	13
7. Hot-bed	19
5. Lawn Mower	16
6. Mr. and Mrs. Wm. Rennie, Sr., at Home	18
— Crimson Rambler Rose	25
14. Combined Harrow, Cultivator and Pulverizer.....	35
10. Dibbler	28
13. Drill Plow with Potato Digger Attachment.....	34
11. Hill-Dropping Seed Drill	29
— Irish Cobbler Potatoes	36
12. Potato Digger and Picker	33
9. Subsoil Plow	27

SMALL FRUITS.

16. Downing Gooseberry	39
17. Fay's Prolific Red Currant	40
19. Kansas Black Cap Raspberry	42
15. Melton Strawberry	37
20. Niagara White Grape.....	43
18. St. Regis Raspberry	41

THE ORCHARD.

23. Clapp's Favorite Pear.....	51
24. King Apples	53
22. Lombard Plum	49
21. Louis Phillippe Cherry.....	47
25. Spraying an Orchard.....	54
26. Spraying Potatoes for Blight.....	56

NO.	BUILDINGS.	PAGE
34.	Basement Floor	68
32.	Basement of Barn.....	66
30.	Double Harpoon Hay Fork.....	63
29.	Elevation of Barn.....	62
27.	Elevation of Implement House.....	58
39.	Elevation of Piggery.....	74
35.	Elevation of Sheep House.....	70
38.	Feed Rack	73
28.	Ground Plan of Implement House.....	60
40.	Ground Plan of Piggery.....	76
37.	Ground Plan of Sheep House.....	72
31.	Hay Carriers and Slings.....	65
33.	Stationary Stanchion.....	68
36.	Swinging Stanchion	71

DRAINING.

44.	Connecting Tiles in Drain.....	82
42.	Crummer	80
43.	Draining	81
41.	Draining Spade	80
—	Early Soy Beans.....	83
—	Japanese Clematis.....	78

IMPLEMENTS.

45.	A Bean Crop in Western Ontario.....	86
46.	Land Roller	87
51.	Adjustable Spike-tooth Harrow.....	93
50.	An Up-to-date Manure Spreader at Work.....	92
49.	Plow with Revolving Coulter.....	91
53.	Set of Ribbers.....	95
47.	Spring Tooth Cultivator.....	89
48.	Stiff Tooth Cultivator.....	90
52.	Wheelbarow Grass Seeder.....	94
54.	Diagram of Farm.....	102
55.	Two-furrow Gang Plow.....	104
56.	Grain Drill	107
59.	Oats in Long Shocks.....	114
58.	Self-binder at Work in an Oat Field.....	112

NO.	PAGE
57. Tolton Pea Harvester.....	108
66. Breed Weeder.....	127
61. Cultivator Frame with Ribbers.....	118
— Earliest Six Weeks' Potatoes.....	133
— Haying at the O.A.C. Farm.....	130
65. Horse Drill for Sowing Field Root Seeds.....	125
63. Horse Hoe or Scuffler.....	120
60. Modern Threshing Machine.....	116
64. Storing Roots in Pit.....	121
62. Turnip Hoe	119

CORN GROWING.

69. Corn Cultivator	138
72. Corn Cutting and Silo.....	140
73. Corn Harvester	141
70. Corn Hoe	139
71. Corn Platform	139
67. Hand Corn Planter.....	136
74. Round Stave Silo.....	143
68. Scuffling at the Ontario Experimental Farm.....	137
— Yellow Dent Corn.....	147

HARVESTING.

75. A Field of Marquis Wheat.....	151
— A Heavy Crop of Golden Vine Peas.....	162
78. Hay Cap	156
83. Hay Loader	163
77. Hay Tedder	153
82. Horse Rake	161
76. Lever Harrow	152
81. Mower with Clover Seed Attachment.....	160
79. Mowing Machine	158
80. Self-Rake Reaper	159

ALFALFA.

84. Alfalfa Inoculated	165
— Root of Alfalfa Plant.....	167

NO.	FENCING.	PAGE
88.	Bracing and Stretching Fence.....	175
87.	Hog, Cattle and Horse Fence.....	175
86.	Horse and Cattle Fence.....	174
89.	London Fence Machine.....	176
85.	Wire Stretcher	173
90.	Woven Wire Gate	176
CATTLE AND HORSES.		
92.	A Young Holstein Bull.....	179
91.	Dehorning Cattle	178
93.	Guernsey Cow—"Murne Cowan".....	181
94.	The Black and White Cattle.....	183
97.	Ayrshire Cow	188
96.	Holstein-Friesian Cow—"Finderne Pride".....	187
98.	Jersey Cow—"Oxford Vixen".....	192
—	Sorghum	191
95.	Two White-faced Beauties.....	186
104.	Aberdeen Angus Cow.....	198
103.	Aberdeen Angus Heifer—1st Prize.....	197
105.	A Porterhouse Roast.....	199
102.	Hereford Cow	196
100.	Cow—Shorthorn "Durham".....	194
101.	Save the Calves.....	195
99.	Shorthorn Heifer—"Nonpareil Bud II.".....	193
106.	Clydesdale Horse.....	201
SHEEP AND SWINE.		
108.	Cotswold	203
110.	Border Leicester.....	205
—	First Prize Ram Lambs.....	210
109.	Lincoln	204
115.	Hampshire Lambs.....	209
111.	Oxford Downs.....	206
112.	Shropshire	207
113.	Southdown	208
114.	Southdown Shearling Ewes.....	209
—	Oxford Down Shearling Ewes.....	212
120.	Portable Pig House.....	215

NO.	PAGE
— True Dwarf Essex Rape.....	216
119. Typical Bacon Hog (Front View).....	213
117. Typical Bacon Hog (Side View).....	211

POULTRY.

127. Adaptable Hover.....	223
129. Barred Plymouth Rocks.....	226
123. Bronze Turkey.....	221
133. Buff Wyandotte.....	230
125. Cypher's Brooder—"B" Style.....	223
132. Everybody Raises Geese.....	229
121. Feeding Time—White Leghorns.....	217
128. Hatching Chickens by Electricity.....	224
124. Modern Incubators.....	222
130. Outdoor Brooder.....	227
134. Pekin Ducks.....	232
126. Portable Hover.....	223
122. Waiting for Meal Time.....	219
131. White Wyandottes.....	228

WESTERN FARMING.

135. Breaking Plow.....	233
140. Broadcast Seeder.....	240
138. Disc Gang Plow.....	238
137. Double Disc Drill.....	236
139. Pulling Flax.....	239
136. Three-furrow Gang Plow.....	235

GENERAL INDEX

	PAGE
Beautifying the Country home.	
Cold Frames—How to Prepare Soil.....	22
Decide the Location for Orchard, Garden and Lawn	9
Hedges and Wind Breaks.....	11
Flower Beds	17
Trimming Evergreen Hedges.....	12
Hardy Climbers.....	24
How to Make a Hot-bed.....	20
Rockery—Planting Ferns and Perennial Flowers....	23
Selection of Hardy Flowering Shrubs.....	17
Summer Flowering Bulbs.....	24
Flower Beds.....	23
Varieties of Flowers and Vegetables.....	21
 The Vegetable Garden.	
How to Prepare the Soil.....	26
Vegetables for a Private Garden.....	28
 Small Fruits.	
Cultivation for Fruits.....	38
How to Plant Grapes.....	42
Strawberries	37
 The Orchard.	
Commercial Apple Growing.....	50
Draining an Orchard.....	45
How to Graft.....	52
Planting an Orchard.....	45
Pruning Apple Trees.....	52
Spraying Fruit Trees.....	52

Farm Implements and Buildings.	PAGE
Buildings, etc., to Harmonize.....	77
Construction of Sheep House.....	72
Farm Barn	59
Implement House.....	57
Location and Dimensions of Building.....	59
Painting Farm Buildings.....	77
Plan of Basement.....	69
Plan of Building.....	71
Style of Building.....	76
Ventilation	73
 Underdraining.	
Construction of Drain.....	80
Depth of Drains.....	79
Grading	81
Laying Tiles.....	82
Size of Drain.....	79
Where Drains are Needed.....	79
 Cultivation of the Soil.	
Summer Fallow.....	87
How to Restore and Maintain Fertility.....	84
 Cultivating and Seeding.	
Destroying Weeds and Weed Seeds.....	95
Increasing the Fertility of the Soil.....	94
Manuring	95
Plowing under Green Crop.....	91
Preparing for Rotation.....	89
Restoring Exhausted Land.....	95
Sowing	94
 Destroying Weeds.	
How to Increase Fertility and Eradicate Weeds....	99
Quality of Seed Grain.....	98
Sowing Clover and Timothy.....	99
Spring Cultivation.....	98
Weeds and Weed Seeds.....	97

	PAGE
Rotation of Crops.	
A Four Years' Course.....	100
Depth to Plant Seeds.....	106
Dividing Farm into Sections.....	100
Fall Cultivation Best Time to Clean the Land.....	103
Manuring in Winter.....	105
Plowing in Summer.....	103
Preparation for Field Roots and Other Hoe Crops	106
Grain Growing.	
Elements of Fertility.....	109
Fall Wheat.....	109
Harvesting Peas.....	107
How to "Shock" Grain.....	113
Improvements in Harvesting Methods.....	111
Prevent Heating.....	110
Quantity to Sow.....	110
Subsoiling Clay Land.....	110
Threshing Peas.....	109
Time to Sow Fall Wheat.....	110
When to Cut Wheat.....	111
Field Root Crops.	
Making Drills, and Sowing Field Roots.....	117
Preparation of the Soil for Swede Turnips.....	124
Quantity of Seed per Acre.....	126
Spring Cultivation for Hoe Crops.....	115
Storing and Ventilating Field Roots.....	122
When and How to Harvest Field Roots.....	121
Exhibition Roots.	
How to Grow Roots for Exhibition.....	129
Potato Growing.	
Cultivation and Drilling for Potatoes.....	131
Digging, Pitting and Storing Potatoes.....	132
How to Cut Potato Sets and Time to Plant.....	131
Rape for Fodder.	
Cultivation and Feeding of Rape.....	134

	PAGE
Corn for Silage.	
Construction of Silos.....	144
Preparing the Land for Corn.....	135
Sowing and Cultivating Corn.....	136
When and How to Harvest Corn.....	140
Fall Cultivation.	
Fall Cultivation after the Hoe Crops.....	148
Cultivation for Spring Crops.	
Clover a Fertilizer, Subsoiler and Flesh Former....	155
Growing Clover for Seed.....	156
Seeding and Caring of Pasture Lands.....	150
When and How to Sow.....	150
Alfalfa Clover.	
Alfalfa—Its Desirable Quality.....	163
Alfalfa Meal.....	166
Fertilization of Alfalfa.....	166
Inoculation of Alfalfa Seed.....	166
Pasture and Soiling Crops.	
Additional Soiling Crops.....	169
Permanent Pasture.....	168
Three Year Rotation.	
Three Years' Rotation of Crops.....	170
Fencing.	
Convenient Portable Fence.....	172
Farm and Garden Gates.....	176
Fencing	172
Permanent Woven Wire Fences.....	174
Portable Woven Wire Fences.....	172
Style and Quality of Fence.....	174
Care and Feeding of Live Stock.	
Autumn Feeding.....	178
Commercial Foods.....	184
Dehorning Cattle.....	179
Economic Feeding.....	177

Care and Feeding of Live Stock—<i>Con.</i>	PAGE
Exercising Animals.....	180
How and When to Feed.....	183
Preparation of Fly Oil.....	185
Ration for Milch Cows.....	183
Shelter in Summer.....	185
Winter Feed.....	180
Breeds of Cattle.	
Fancy Butter Cow.....	189
Increasing Production.....	189
Popular Dairy Cows.....	189
Selecting a Milch Cow.....	189
Cattle for Beef.	
Beef Breeds.....	193
Buying Steers for Winter Feeding.....	199
Care of Calves.....	199
Horses.	
Care and Feeding of Horses.....	202
Horses on the Farm.....	200
Summer Ration.....	202
Sheep.	
Dipping Sheep.....	208
Feeding of Ewes.....	207
Feeding Sheep.....	208
Special Care for Long Wool.....	203
Various Breeds of Sheep.....	203
Winter Care.....	208
Winter Feeding.....	209
Swine.	
Brood Sow.....	214
Feed for Young Pigs.....	214
Feeding Swine.....	212
Summer Food for Swine.....	215
Winter Food and Exercise.....	215

Poultry.	PAGE
Care of Hens when Laying.....	220
Feed and Water Trough.....	218
General Purpose Breeds.....	225
Hens vs. Incubator.....	225
How to Feed.....	220
Management of Ducks.....	225
Plan of Poultry House.....	217
Water and Feed.....	225
When to Mate.....	222
When to Sell.....	231
Winter Eggs.....	220
Western Farming.	
Flax Culture.....	239
Semi-Arid Lands.....	240
The Canadian West.....	233
System.	
Keep Accounts.....	243
System	243

